

MINDEO

MS3390 Programmable Mobile Scanner User Manual



Version: MS3390_UM_EN_V1.2.1

Notice

Before operating this mobile scanner, please make sure you carefully read the following information to ensure that your scanner is able to perform at the level for which it is designed.

1. All software, including firmware, furnished to the user is on a licensed basis.
2. The right is reserved to make changes to any software or product to improve reliability, function, or design.
3. The contents of this manual are subject to change without notice.
4. The manufacturer assumes no responsibility for any loss or claims by third parties which may arise from the use of this manual.
5. Do not throw or drop the scanner or otherwise subject it to strong impact, which can damage the scanner, interrupt program execution, corrupt memory contents, or otherwise interfere with proper operation.
6. A standard packing includes a mobile scanner, a USB cable and a CD (containing software and electrical manuals). Accessory includes a Bluetooth USB adapter BA2110 which supports reliable wireless data transmission and an AC/DC adaptor for battery charge.
7. **Please charge the battery before the first time of use.**
8. The term “scanner” as used in this manual denotes the MS3390 mobile scanner unless otherwise noted.

Contents

Notice.....	i
1 Specifications	1
1-1 Technical specifications	1
1-2 Default settings for each barcode.....	3
1-3 Decode zone.....	4
1-4 Dimensions	5
1-5 Parts of the scanner.....	6
1-6 Parts of the Bluetooth USB adapter BA2110.....	7
1-7 Keys, actions and features	8
2 Introduction to installation.....	9
2-1 Installing a USB HID keyboard wired scanner.....	9
2-2 Installing a USB virtual COM wired scanner.....	9
2-3 Attaching the neck/wrist strap	10
2-4 Replacing the Lithium-ion battery	10
3 Getting started.....	11
3-1 Power on/off scanner.....	11
3-2 Charge battery	11
3-3 Enter/Exit sleep mode	11
3-4 Power on/off Bluetooth.....	11
4 Introduction to LCD display	13
4-1 LCD display icons	13
4-2 LCD display menu.....	14
5 Operations of the scanner	17
5-1 Scan	17
5-2 Data Transfer.....	21
5-3 System Setting - Bluetooth	24
5-3-1 Bluetooth functionalities.....	24
5-3-2 Configure Bluetooth HID keyboard profile communication	24
5-3-3 Configure Bluetooth SPP slave profile communication	27
5-3-4 Configure Bluetooth SPP master profile communication	29
5-3-5 Configure Bluetooth USB adapter BA2110	30
5-3-6 Configure the profile of BA2110	31
5-4 System Setting - General.....	31
5-5 System Information	33
6 User customized application software for MS3390	35
7 Barcode programming instructions	37
Programming instruction	37
UPC-A.....	37

UPC-A.....	38
UPC-E.....	39
EAN-13.....	40
EAN-8.....	41
Code 39.....	42
Interleaved 2 of 5.....	44
Industrial 2 of 5.....	45
Matrix 2 of 5.....	46
Codabar.....	47
Code 128.....	48
Code 93.....	49
Code 11.....	50
MSI/Plessey.....	51
UK/Plessey.....	52
UCC/EAN 128.....	53
China Post.....	54
GS1 DataBar (GS1 DataBar Truncated).....	55
GS1 DataBar Limited.....	56
GS1 DataBar Expanded.....	57
PDF417.....	58
MicroPDF417.....	59
China Finance.....	60
G1-G6 & FN1 substitution string setting.....	62
G1-G4 string position & Code ID position.....	65
String transmission.....	66
Test Chart.....	68
Test Chart (Continued).....	69
ASCII Table.....	70
Barcode representing non-printable character.....	71
Configuration alphanumeric entry barcode.....	72

1 Specifications

1-1 Technical specifications

Table 1-1. Technical specifications of the scanner

Data storage	8 MB for out of range batch/data batch mode: 559,240 barcodes (each barcode is of 15 bytes); 53MB for U Disk mode: 3,635,063 barcodes (each barcode is of 15 bytes).
Radio link	2.4 ~ 2.5GHz (ISM band), Bluetooth V2.1+EDR, class 2
Working range	30 meters (line of sight)
Interface	Bluetooth scanner: Human Interface Device (HID) Keyboard Serial Port Profile (SPP), operating as either a master or a slave USB wired scanner: USB HID keyboard USB virtual COM U Disk (with which barcode data is stored in a txt file rather than sent to a host via Bluetooth/USB)
Keyboard layout	USA, Turkish F/Q, French, Italian, Spanish, Slovak, Denmark, Japanese, German
Dimensions	Length × Width × Depth: 11.0 × 4.3 × 2.7 cm
Weight	89g
Color	White/Black/Customization
Battery	950 mAh Lithium-ion battery
Charge time	Fully charged (>80%) in 3.5 hours
Charge current	300 mA
Case material	ABS
Light source	650 nm visible laser diode
Scanning angle	±50°, ±65°, ±35° (Skew, Pitch, Roll)
Scan rate	100±10 times/sec
Decode capability	UPC-A, UPC-E, EAN-13, EAN-8, ISBN/ISSN, Code 39, Code 39 full ASCII, Code 32, Trioptic Code 39, Interleaved 2 of 5, Industrial 2 of 5, Matrix 2 of 5, Codabar (NW7), Code 128, Code 93, Code 11 (USD-8), MSI/Plessey, UK/Plessey, UCC/EAN 128, China Post, GS1 Data Bar (formerly RSS) variants
Indicator	Beeper, LED, Vibrator
Display	LCD monochrome display (128 × 64) with LED backlight
Operating mode	Handheld
Programming method	Manual (reading special barcode), On-Screen (pressing special keys)
Firmware upgrade	Online via USB interface
Temperature	0° to 50°C (32° to 120°F), Operating; -40° to 60°C (-40° to 140°F), Storage
Humidity	5% to 95% (non-condensing)
Input Voltage	4.75V – 5.25V
Operating current	5mA (sleeping); 165mA (scanning); 110mA (transmitting)

Standby time	Over 7 days	
Operating time	6 hours	
Read barcodes per charge	Over 20,000 scans per charge	
Decoding depth & Max. resolution	(1 mil = 0.0254mm) Long-range series 5 mil: 35-160mm 10 mil: 20-320mm 15 mil: 25-440mm 20 mil: 30-565mm 30 mil: 40-740mm 55 mil: 75-985mm	High-density series 3 mil: 45-90mm 5 mil: 22-130mm 10 mil: 12-225mm 15 mil: 20-305mm 20 mil: 25-395mm 55 mil: 80-730mm
Safety	Laser safety: EN60825-1, class 1 EMC: EN 55022, EN 55024 Electrical safety: EN 60950-1 ESD: ± 8KV air discharge, ± 4KV direct discharge Drop resistance: Multiple 1.5m (4.9ft) drops to concrete Protection class: IP64 Environmental: RoHS compliant	

Table 1-2. Technical specifications of BA2110

Radio link	2.4 ~ 2.5GHz (ISM band), Bluetooth V2.1+EDR, class 2
Working range	30 meters (line of sight)
Dimensions	Length × Width × Depth: 7.6 × 2.2 × 0.8 cm
Weight	12g

Notes:

- 1- BA2100 is a Bluetooth USB adapter made by the manufacturer, which supports reliable wireless data transmission.
- 2- BA2100 is an optional accessory.

1-2 Default settings for each barcode

Table 1-3. Default settings

Code type	Read enable	Check digit verification	Check digit transmission	Min. code length	Proprietary code ID	AIM code ID
UPC-A	√	√	√	(12) ²	A	JEm
UPC-E	√	√	√	(8) ²	D	JEm
EAN-13	√	√	√	(13) ²	A	JEm
EAN-8	√	√	√	(8) ²	C	JEm
ISBN/ISSN ¹	√	√	√	(13) ²	A	JEm
Code 39	√	-	-	1	M	JAm
Interleaved 2 of 5	√	-	-	6	I	JIm
Industrial 2 of 5	-	-	-	4	H	JIm
Matrix 2 of 5	√	-	-	6	X	JIm
Codabar	√	-	-	4	N	JFm
Code 128	√	√	-	1	K	JCm
Code 93	√	√	-	1	L	JGm
Code 11	-	√	-	4	V	-
MSI/Plessey	-	-	-	4	O	JMm
UK/Plessey	√	√	-	1	U	JMm
UCC/EAN 128	√	√	-	1	K	JCm
China Post	√	-	-	(11) ²	T	JIm
GS1 DataBar	√	-	-	(16) ²	R	Jem
GS1 DataBar Truncated ³	√	-	-	(16) ²	R	Jem
GS1 DataBar Limited	√	-	-	(16) ²	R	Jem
GS1 DataBar Expanded	√	-	-	1	R	Jem

Note: ¹The settings for ISBN/ISSN and EAN-13 must be the same.

² Fixed-length barcodes.

³The settings for GS1 DataBar Truncated and GS1 DataBar must be the same.

1-3 Decode zone

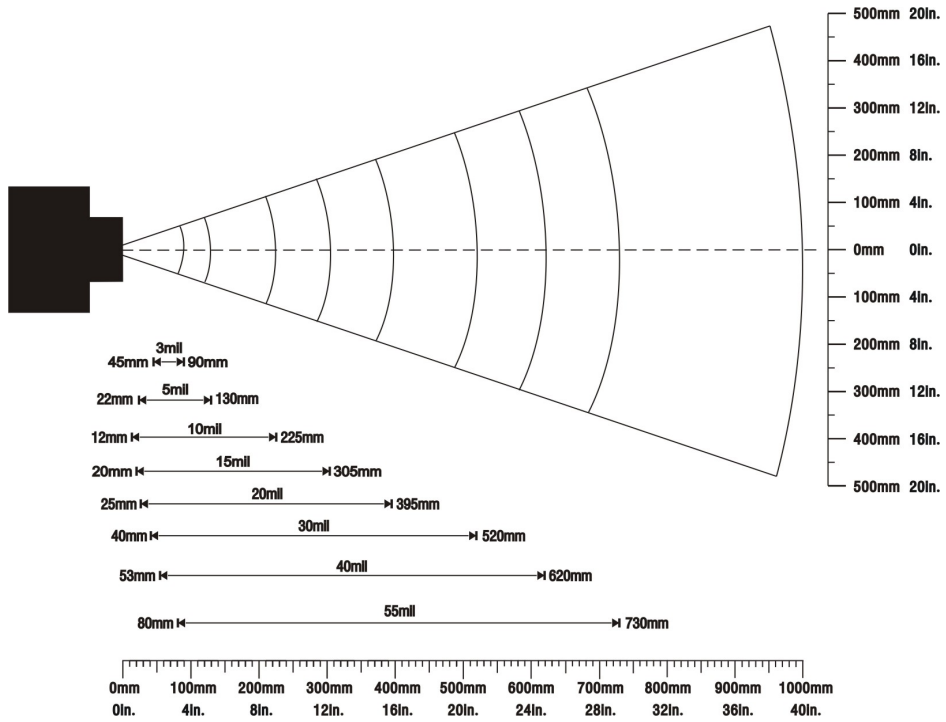

Figure 1-1. Decode zone of high-density series

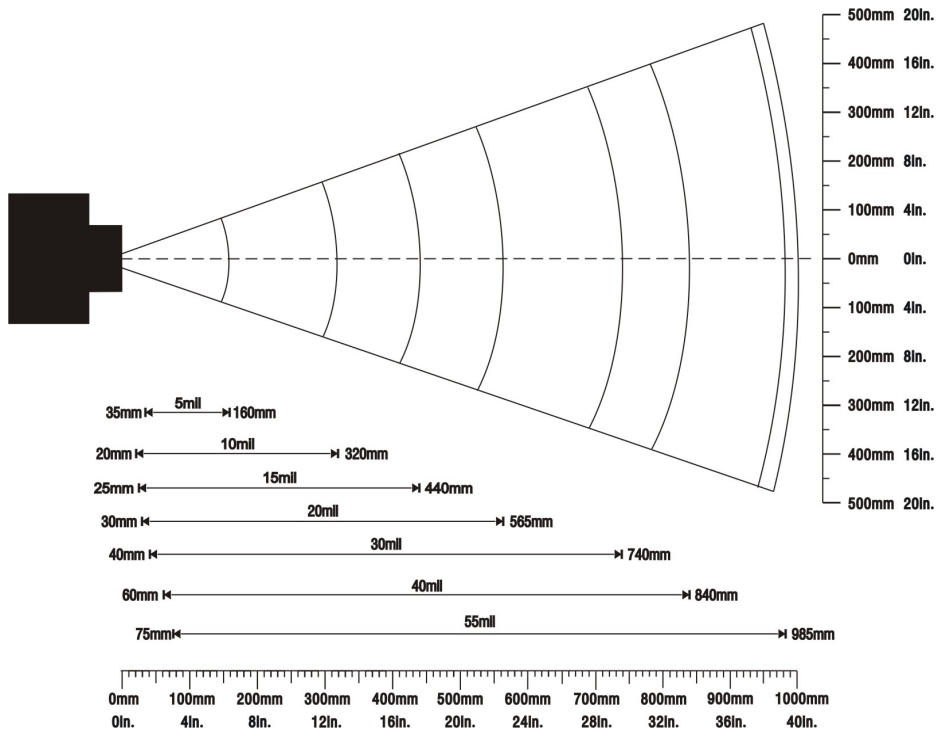

Figure 1-2. Decode zone of long-range series

1-4 Dimensions

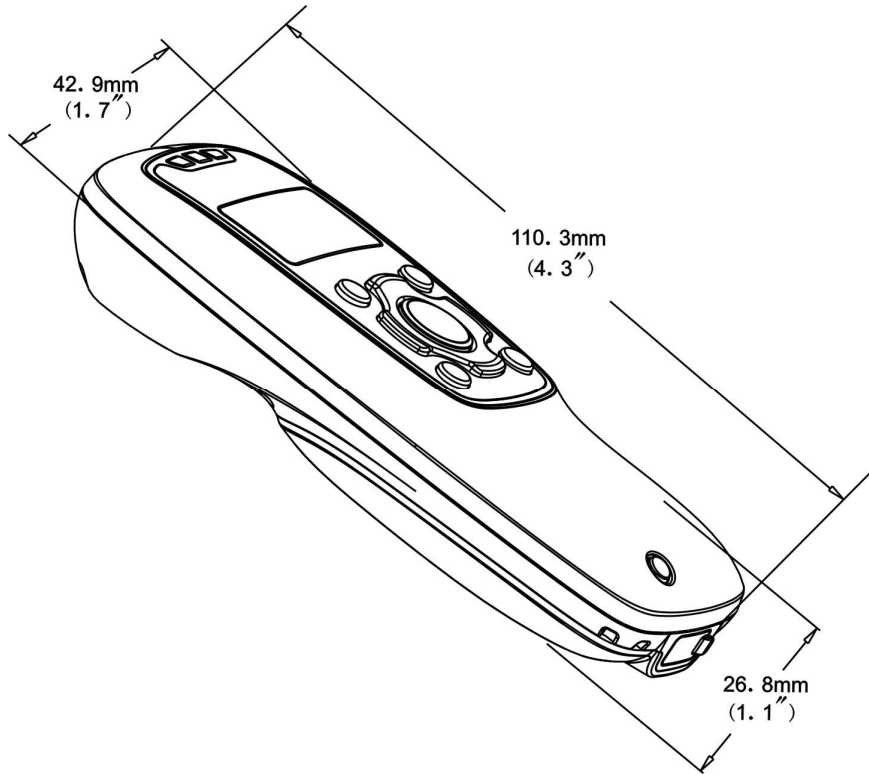

Figure 1-3. Dimensions of the scanner

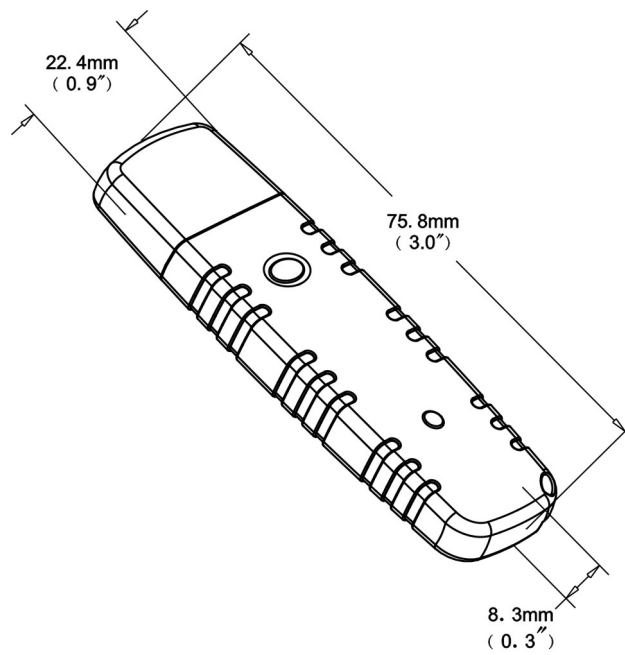

Figure 1-4. Dimensions of the Bluetooth USB adapter

1-5 Parts of the scanner

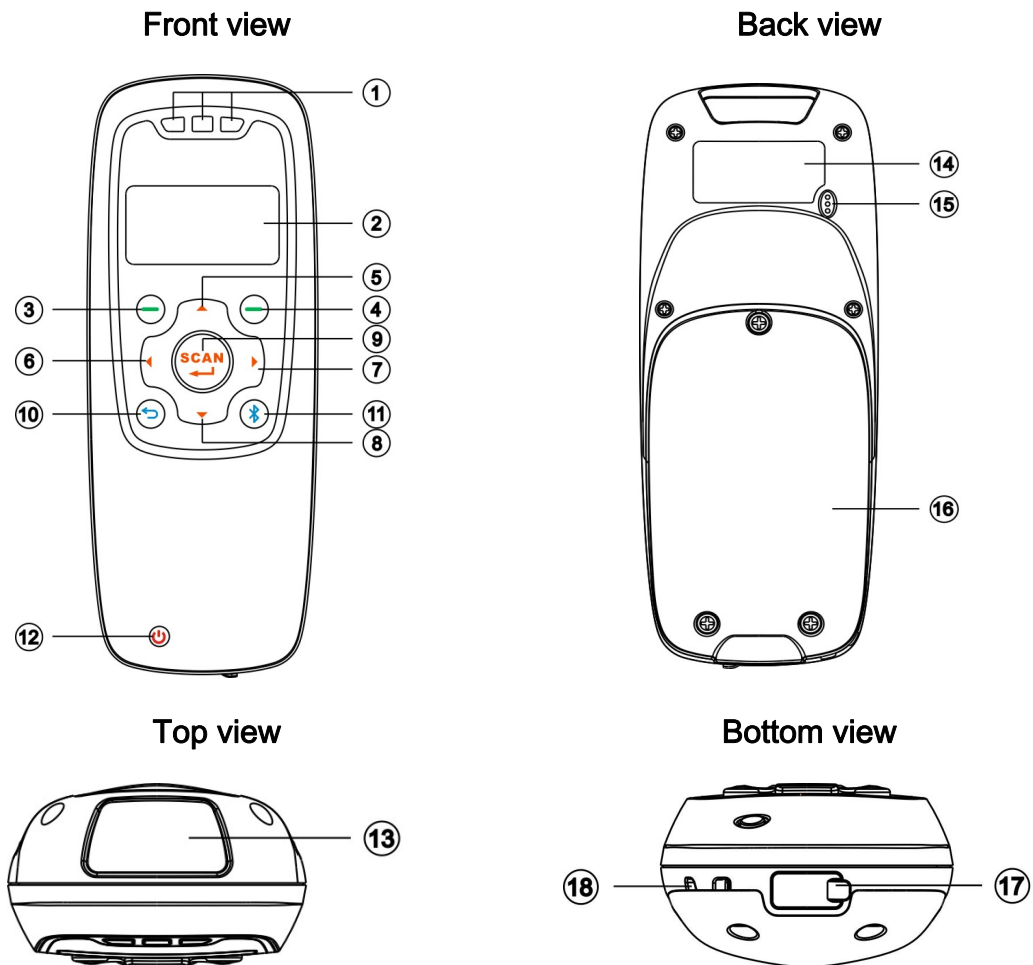

Figure 1-5. Parts of the scanner

- ① Blue LED (Bluetooth power); Green LED (Decode success); Red LED (Charging indicator)
- ② LCD
- ③ Left soft key
- ④ Right soft key
- ⑤ Up navigation key
- ⑥ Left navigation key
- ⑦ Right navigation key
- ⑧ Down navigation key
- ⑨ Scan/Select key
- ⑩ Return key
- ⑪ Bluetooth on/off key
- ⑫ Power/Sleep key
- ⑬ Scan window
- ⑭ Label
- ⑮ Beeper
- ⑯ Battery cover
- ⑰ Mini USB port / Battery charging port (Lift cover)
- ⑱ Hook for neck/wrist strap

1-6 Parts of the Bluetooth USB adapter BA2110

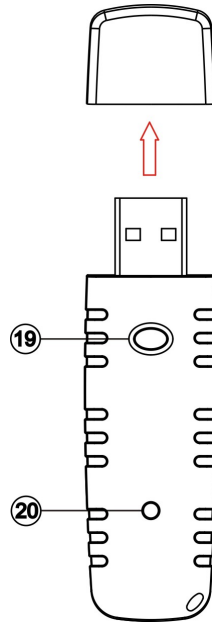

Figure 1-6. Parts of the Bluetooth USB adapter BA2110

- ①9 Reset/Firmware upgrade key
- ②0 Green LED (Power/Data transmission)

1-7 Keys, actions and features

Operations, such as scrolling and selecting menus, moving a cursor, or scanning a barcode, are controlled by trigger keys and stroke keys.

Table 1-4. Key functions

Part Position ¹	Key/Action/Feature	Description
③	Left soft key	Functionalities are identified by the screen display. In general, the acknowledge/non-acknowledge of operations are done by pressing a soft key.
④	Right soft key	
⑨	Scan/Select key	is pressed to scan barcodes when the scanner is not in a menu status; the select key is pressed to select items when a menu is activated.
⑤	Up navigation key	is pressed to move cursor upward/downward.
⑧	Down navigation key	
⑥	Left navigation key	is pressed to move cursor leftward/rightward.
⑦	Right navigation key	
⑩	Return key	is pressed to return to previous menu by one step.
⑪	Bluetooth on/off key	is pressed to turn on/off the Bluetooth power.
⑫	Power/Sleep key	is pressed long to power on/off a scanner; the key is pressed short to enter/exit sleep mode.

Note: ¹See **Parts of the scanner** for the information about position of keys.

2 Introduction to installation

2-1 Installing a USB HID keyboard wired scanner

Note: The default interface of the scanner is BT HID Keyboard. Please change the interface to USB HID Keyboard (See Data Transfer→USB HID Keyboard).

1. Refer to Figure 2-1, plug one end of the USB cable to the scanner. Plug the other end into the USB port of the computer.
2. For example: Using Microsoft Windows operation system, the system gives message on “new hardware found – USB HID input device found”, then driver will be installed on request.
3. After successfully installing the new hardware, message will be given: “hardware installed successfully and ready to use”.
4. If any problem is encountered during the installation process, unplug the USB cable from the computer and repeat step 1-2.

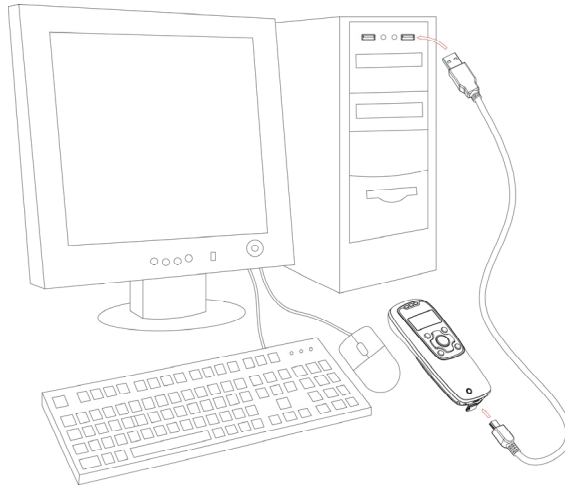

Figure 2-1. Diagram of connecting the scanner to PC

2-2 Installing a USB virtual COM wired scanner

Note: The default interface of the scanner is BT HID Keyboard. Please change the interface to USB Virtual COM.

1. Refer to Figure 2-1, plug one end of the USB cable to the scanner. Plug the other end into the USB port of the computer.
2. For example: Using Microsoft Windows operation system, the system gives message on “new hardware found – USB Virtual COM found” for USB virtual COM, then driver will be installed on request.
3. After successfully installing the new hardware, message will be given: “hardware installed successfully and ready to use”.
4. If any problem is encountered during the installation process, unplug the USB cable from the

computer and repeat step 1 to step 2.

2-3 Attaching the neck/wrist strap

Note: The neck/wrist strap protects the scanner from being damaged as a result of it being dropped by mistake during movement.

1. Refer to Figure 2-2, remove the 3 screws from the battery cover (one at a time).
2. Attach the neck/wrist strap by hanging the strap ring around the raised part at the corner.
3. Screw in the 3 screws to tighten the scanner and the battery cover.

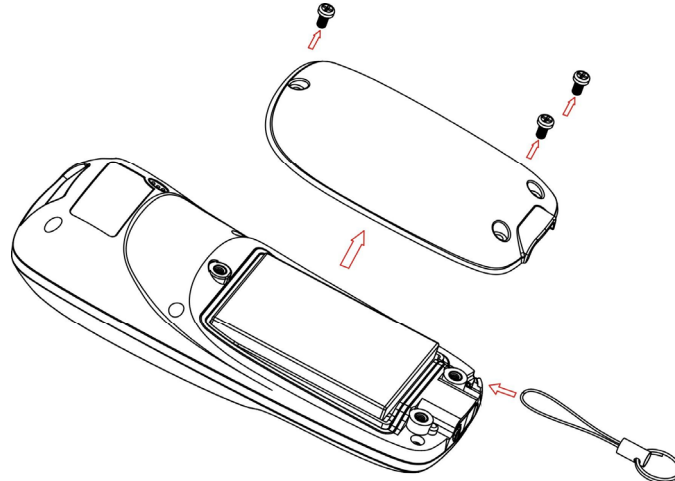

Figure 2-2. Diagram of attaching the neck/wrist strap

2-4 Replacing the Lithium-ion battery

1. Refer to Figure 2-2, remove the 3 screws from the battery cover (one at a time).
2. Refer to Figure 2-3, load the battery while sliding it with the connection on the battery pack on the scanner body.
3. Re-place the battery cover, screw in the 3 screws to tighten the scanner and the battery cover.

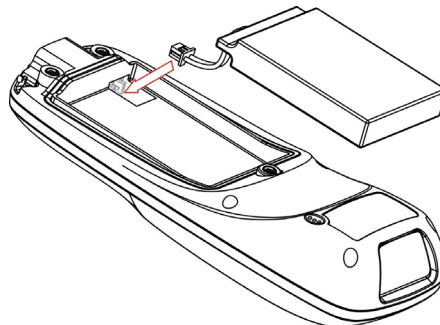

Figure 2-3. Diagram of replacing the Lithium-ion battery

3 Getting started

3-1 Power on/off scanner

Power on scanner:

Press the Power/Sleep key  (see Parts of the scanner) for two seconds.

Power off scanner:

Press the Power/Sleep key  (see Parts of the scanner) for two seconds.

3-2 Charge battery

1. **Please charge the battery before the first time of use.** There are two methods of charging battery as demonstrated in Figure 3-1. The charging indicator (red LED) on the scanner is turned on when the charging is in process. When the charging process completes, the red LED is turned off.
2. Charging time: 3.5 hours for fully charged.
3. In scanning status, the icon  is seen at the top of the screen display when the scanner is connected to a PC with the USB cable.

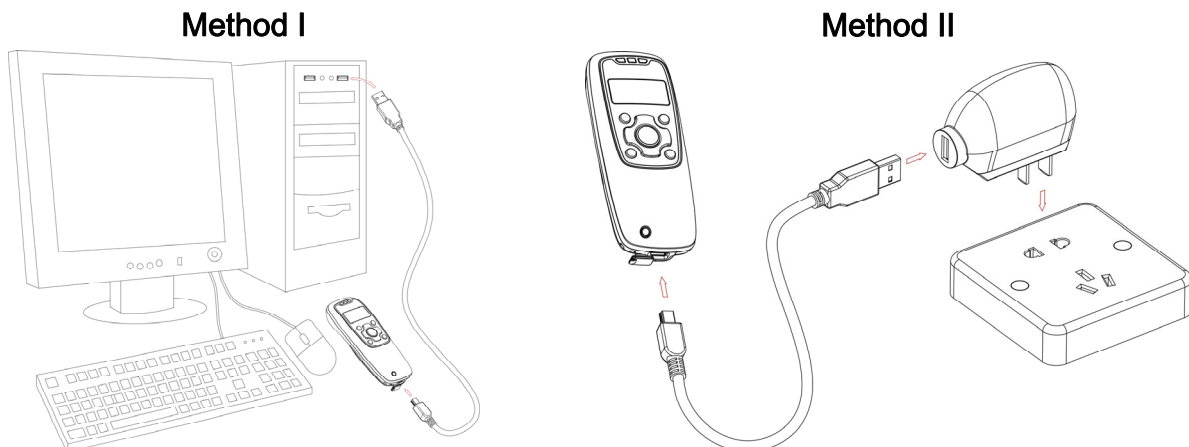



Figure 3-1. Diagram of charging battery

3-3 Enter/Exit sleep mode

Enter sleep mode:

Press the Power/Sleep key  (see **Parts of the scanner** ) for 0.5 seconds.

Exit sleep mode:

Press the Power/Sleep key  for 0.5 seconds.

3-4 Power on/off Bluetooth

Bluetooth indicator:

In scanning status, the status of the Bluetooth is shown by icons.



	Bluetooth is off.
---	-------------------

The status of the Bluetooth is also indicated by the blue LED.

on	Bluetooth is on.
off	Bluetooth is off.

Power off Bluetooth:

Press the Bluetooth key  (see **Parts of the scanner** ⑪).

Power on Bluetooth:

Press the Bluetooth key .







4 Introduction to LCD display

4-1 LCD display icons

Notes:

- 1- The LCD screen is designed to display barcode scanning, Bluetooth network establishing, data transfer, system setting and other information.
- 2- The display area is 64 dots (V) by 128 dots (H). The backlight will be switched off automatically if time of no operation exceeds a programmable duration (see System Setting→Backlight Timeout).



Table 4-1. LCD display icons

Icon	Description
	Bluetooth network is working.
	Bluetooth network is disconnected.
	Bluetooth module is on.
	Bluetooth module is off.
	Scanner is connected to a PC (or other instrument) with USB cable.
	Battery capacity (from the left): <ul style="list-style-type: none">• Battery is fully charged (100% - 75% charge remains).• 75% - 50% charge remains.• 50% - 25% charge remains.• 25% - 10% charge remains.• 10% - no charge remains. When the battery capacity is lower than 10%, the battery icon blinks and an error tone sounds once every minute.

4-2 LCD display menu

The Home menu consists of five items, which are described in details in the following chapters. Table 4-2 depicts the hierarchy chart of the LCD display menu.

Table 4-2. LCD display menu

Menu	Hierarchy chart
	<div style="display: flex; align-items: center;"> <div style="margin-right: 20px;"> <div style="border: 1px solid black; padding: 2px; width: 60px; text-align: center;">Scan</div> <div style="margin-left: 10px;">→</div> <div style="border: 1px solid black; padding: 2px; width: 60px; text-align: center;">Scan</div> </div> <div style="margin-left: 20px;"> <ul style="list-style-type: none"> → Scan Mode → <div style="border: 1px solid black; padding: 2px; width: 100px;">1. Good-read off * 2. Momentary 3. Continuous</div> → Quantity Enter → <div style="border: 1px solid black; padding: 2px; width: 100px;">1.Disable* 2.Repeat Output 3.Output Quantity</div> → Add Time → <div style="border: 1px solid black; padding: 2px; width: 100px;">1.Disable* 2.Enable</div> → Add Date → <div style="border: 1px solid black; padding: 2px; width: 100px;">1.Disable* 2.Enable</div> → Input Barcode → <div style="border: 1px solid black; padding: 2px; width: 100px;">Send</div> → Database Query → <div style="border: 1px solid black; padding: 2px; width: 100px;">1.Disable* 2.Enable</div> → Avoid Duplication → <div style="border: 1px solid black; padding: 2px; width: 100px;">1.Disable* 2.Enable</div> → Barcode Statistics → <div style="border: 1px solid black; padding: 2px; width: 100px;">1.Disable* 2.Enable</div> → Transfer Confirm → <div style="border: 1px solid black; padding: 2px; width: 100px;">1.Disable* 2.Enable</div> </div> </div>
	<div style="display: flex; align-items: center;"> <div style="margin-right: 20px;"> <div style="border: 1px solid black; padding: 2px; width: 100px; text-align: center;">Data Transfer</div> </div> <div style="margin-left: 20px;"> <ul style="list-style-type: none"> → Bluetooth* → <div style="border: 1px solid black; padding: 2px; width: 100px;">Out of Range → <div style="border: 1px solid black; padding: 2px; width: 100px;">1.Disable* 2.Enable</div></div> → Bluetooth* → <div style="border: 1px solid black; padding: 2px; width: 100px;">Auto Reconnection → <div style="border: 1px solid black; padding: 2px; width: 100px;">1.Disable* 2.Enable</div></div> → Bluetooth* → <div style="border: 1px solid black; padding: 2px; width: 100px;">Inter-character delay</div> → Bluetooth* → <div style="border: 1px solid black; padding: 2px; width: 100px;">BA2110 Connect Time</div> → USB HID Keyboard → USB Virtual COM → U-Disk → <div style="border: 1px solid black; padding: 2px; width: 100px;">Create New File → <div style="border: 1px solid black; padding: 2px; width: 100px;">Empty File</div></div> → U-Disk → <div style="border: 1px solid black; padding: 2px; width: 100px;">List Files → <div style="border: 1px solid black; padding: 2px; width: 100px;">Delete File</div></div> → U-Disk → <div style="border: 1px solid black; padding: 2px; width: 100px;">Format</div> → Data Batch → <div style="border: 1px solid black; padding: 2px; width: 100px;">Send Batch Data</div> → Data Batch → <div style="border: 1px solid black; padding: 2px; width: 100px;">Interface → <div style="border: 1px solid black; padding: 2px; width: 100px;">1.Bluetooth* 2.USB HID Keyboard 3.USB Virtual COM</div></div> → Data Batch → <div style="border: 1px solid black; padding: 2px; width: 100px;">Date Statistics → <div style="border: 1px solid black; padding: 2px; width: 100px;">1.Disable* 2.Enable</div></div> → Data Batch → <div style="border: 1px solid black; padding: 2px; width: 100px;">Add Separator</div> </div> </div>

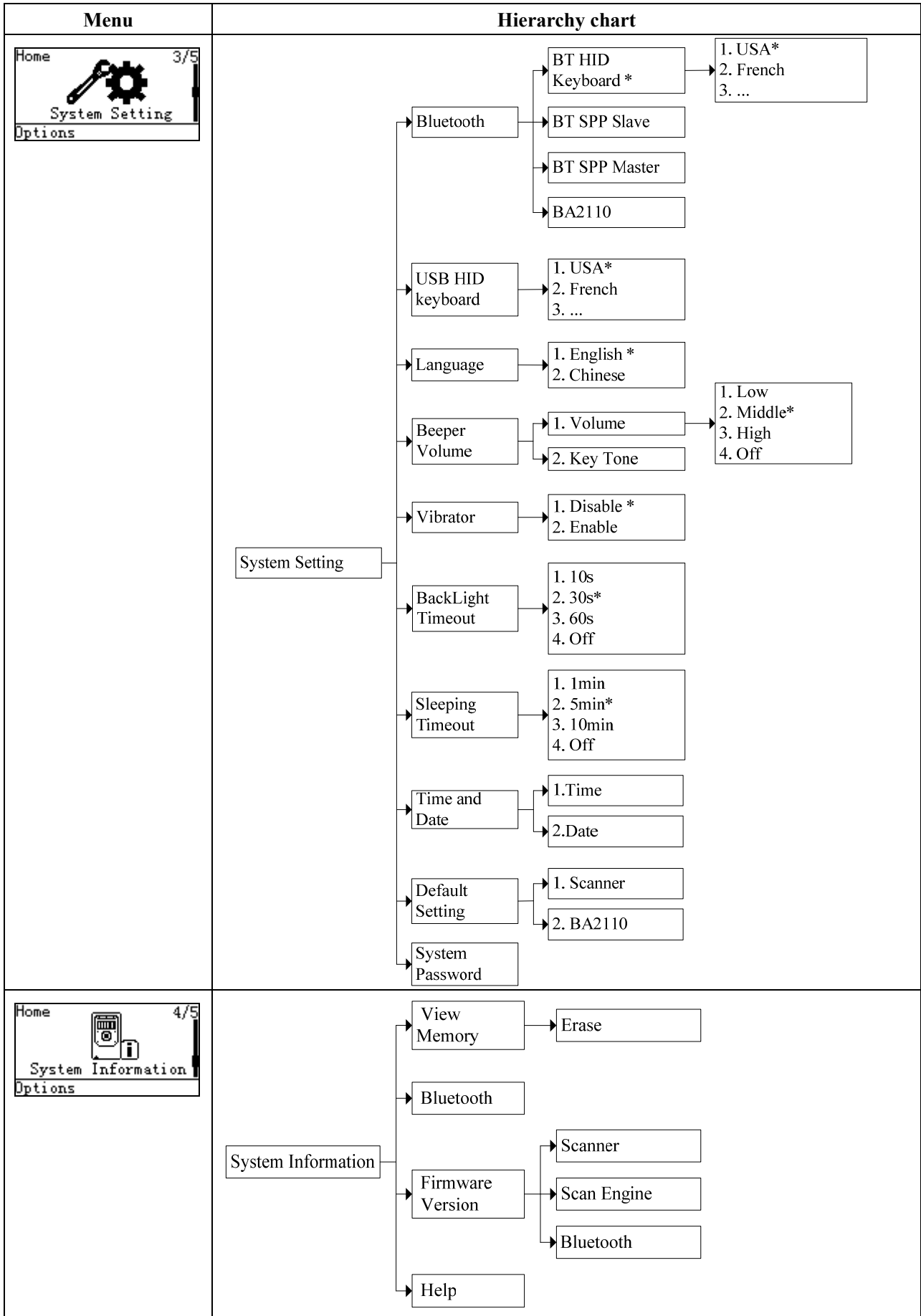

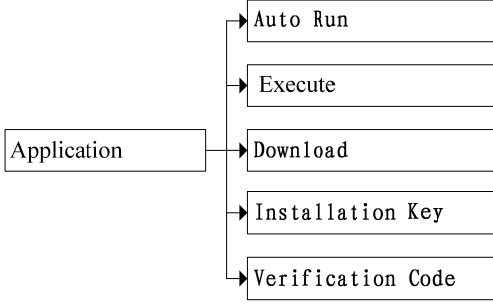
Menu	Hierarchy chart
	
<p>Note: Items that are labeled ‘*’ are default selections.</p>	

5 Operations of the scanner

Note:

1. Please establish a Bluetooth network and hold the scanner in the range of the network before the first time of scanning barcodes (See chapters of Configure Bluetooth HID keyboard profile communication, Configure Bluetooth SPP slave profile communication, and Configure Bluetooth SPP master profile communication).
2. The scanner can perform a barcode scan operation even though no Bluetooth network is available. However, the scanner may react in a way that differs from what is described here if no Bluetooth network is working.

5-1 Scan

Steps:

Step 1: When the scanner is powered on, the LCD screen is displayed as below.



Step 2: Hold the scanner close to the barcode and press the Scan Key .

Note: When the scanner is scanning, ensure the scan line crosses every bar and space of the symbol.



Step 3: The scanner port emits a laser to scan the barcode. The decode success indicator lights green when the scan is successful. The window will show as below.

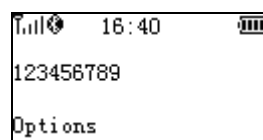

Scan mode

Good-read off - The Scan key must be pressed once to activate scanning. The light source of scanner stops scanning when there is a successful reading or no code is decoded after the Stand-by duration elapsed.

Momentary - The Scan key acts as a switch. Press the key to activate scanning and release the key to stop scanning. The light source of scanner stops scanning when there is a successful reading or no code is decoded after the Stand-by duration elapsed.

Continuous - The scanner always keeps scanning, and it does not matter when the Scan key is released or duration is elapsed.

Quantity enter

User can disable the Quantity Enter and select Repeat Output mode or Output Quantity mode. When Quantity Enter is enabled, user can set the number (0 to 9999) of barcode transmissions. For example, a barcode “123456789” is read. When user select Repeat Output mode, Five “123456789” will be received by the host, given that the quantity is 5. When user selects Output Quantity mode, “123456789, 5” will be received by the host, given that the quantity is 5. The quantity decides how many identify barcodes a host receives upon a single successful read.

Separator Setting- When user selects Output Quantity mode, the barcode and quantity will be separated, the default separator is comma <,>. Separator Setting is **Quantity enter-Output Quantity-Options**. By using the virtual keypad, user can input character manually. The length of the separator string can be at most 10 characters.

The following steps demonstrate the procedure to set a quantity.

Step 1: Enable Quantity Enter, press the Scan Key to read a barcode.

Example display:

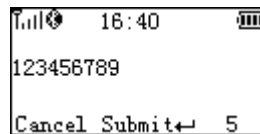

Step 2: Press Right Soft Key to the window below.

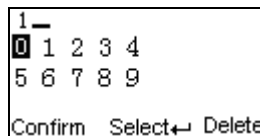

Step 3: Use Navigation Keys to move the cursor, Scan/Select Key to select number(s), Right Soft Key to delete selected number(s). And then press Left Soft Key to continue.

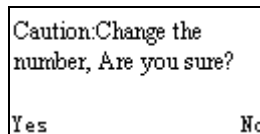

Step 4: Finally press Left Soft Key to complete.

Add Time/Date

The time/data information can be added as an appendix to a barcode by enabling the Add Time/Date.

For example:

When Add Time is enabled, a barcode “123456789” is read in 12:00:00, “123456789,12:00:00” will be

received by the host.

When Add Time and Add Date is enabled, a barcode “123456789” is read in 12:00:00 at 25.05.2012, “123456789,12:00:00, 25.05.2012” will be received by the host

Input barcode

Using the virtual keypad, user can input a barcode manually, and then send the barcode to the host or store in the scanner.

Make sure a communication link (Bluetooth network or USB cable) is working.

Database management support

Database management support includes: database query, same barcode avoidance and barcode statistic.

Note: database query, same barcode avoidance and barcode statistic are mutually exclusive. If database query is enabled then same barcode avoidance and barcode statistic functions are disabled automatically. Similarly if either same barcode avoidance or barcode statistic function is enabled then other two functions are disabled automatically.

1 Database query

Database query includes: After successfully scanning the barcode, the barcode information would be displayed on the LCD screen. The database query function demands the use of MS3 DB database supporting software tool to generate database files: *.IDX and *.DAT. By applying the database query functionality, the user can rapidly and accurately locate the barcode information.

When user scan the barcode, the scanner would perform a database searching upon the database files stored in the flash disk and display the barcode information if matching is found when the database query function is enabled. User would require scrolling to left or right for more information displayed on the LCD screen. If no matching is found then “No Record” is displayed on the LCD screen.

Example:

User barcode information as follows:

	A	B	C	D
1	Barcode	Trade Name	Price	Place of Production
2	12345670	Computer	¥3000.00	Shenzhen

When user scan the barcode "12345670", The scanner would display "Computer, ¥3000.00, Shenzhen" on the LCD screen.

Note: The default database files are named SYS_DB.IDX and SYS_DB.DAT. In order to utilize the database functionality user should NOT change these file names and these two files are properly stored to the flash disk.

2 Avoid Duplication

When user scans the barcode, the scanner retrieves the database for a match in the meantime. If the barcode does not exist in the database, the barcode will be recorded into the database file, sent out or stored in USB Disk. Neither transmission nor store operation will be performed if a barcode already exists in the database. Furthermore, the "Barcode already exists" message is displayed on the LCD screen.

User can clear the previous barcode record by entering the same barcode avoidance setting menu page and pressing the left soft key (**clear**).

3 Barcode Statistics

The scanner will automatically count and display the number of barcodes which have been sent or stored successfully when Barcode Statistics function is enabled.

User can clear the previous barcode record by entering the barcode statistic function setting menu page and pressing the left soft key (**clear**).

Transfer confirm

User can select to enable/disable the transfer confirm. When the scan is successful, The scanner would point out that whether confirm to transfer this barcode. User can press left soft key to cancel transfer or press right soft key to confirm transfer barcode data.

Set Separator

The barcode and Time/Data/quantity will be separated by separator, the default separator is comma <,>. By using the virtual keypad, user can input character manually. The length of the separator string can be at most 10 characters.

Example1: A barcode “123456789” is read in 12:00:00 at 25.05.2012. When user selects Output Quantity mode, “123456789, 5” will be received by the host, given that the quantity is 5.

123456789,5,12:00:00,25.05.2012

Example2: When user enables the Data Statistics, the barcode and quantity will be separated, the eighth barcode is “123456789” in the example below.

123456789,8

5-2 Data Transfer

Bluetooth

See **System Setting - Bluetooth** for instructions to establish a Bluetooth network. Three options are listed below.

Out of range batch- The scanner starts storing barcode data when it loses its connection to a remote host (for example, when a user holding the scanner walks out of range). Data transmission is triggered by reestablishing the connection with the host (for example, when a user holding the scanner walks back into range).

Auto reconnection- When scanner’s Bluetooth is power on, it will try to establish the wireless connection with the host which it last connected, if Auto Reconnection is enabled.

Inter-char delay- Inter-character delay is abbreviated to Inter-char delay. This delay is inserted after each data character transmitted when configure Bluetooth to HID keyboard profile. Some Bluetooth communication needs large delay to avoid data missing. This default delay is set to 8 milliseconds.

BA2110 Connect Time- This is a standby time for the user to plug the BA2110 into PC after scanned the barcode on the back of BA2110. The default standby time is set to 10 seconds. (For more detail, please refers to **5-3-6 Configure the profile of BA2110**).

USB HID keyboard

When the scanner is USB connected to a PC, it will be identified as a USB HID keyboard and behaves as a USB wired scanner.

USB Virtual COM

When the scanner is USB connected to a PC, it will be identified as a USB Virtual COM and acts as a RS-232 wired scanner.

U Disk

Barcode data is always stored in a text file (TXT file), that is, the scanner functions as a barcode data collector. The scanner will be identified as a USB removable driver when it is USB connected to a PC.

The scanner decides target file to store barcodes according to following rules:

- ✓ If a file is selected by the user, the selected file will be the target file.
- ✓ If there is no file in the U-Disk, a file will be created and named "TARGET.txt" by the scanner when it is powered on or restart. In this case, TARGET.txt will be the target file.
- ✓ The file selected to be the target file is labeled ✓.

Create New Files

Note:

1. Files can be opened/edited/saved/renamed/deleted by the user of a PC and created/emptied/deleted by the user of a mobile scanner.
2. A valid filename, not including the suffix, is composed of up to 8 characters from three groups: Upper case letters "A"–"Z", Numbers 0–9 and special sign ! # \$ % & ' () - @ ^ _ ` { } ~ .
3. Only part of the filename will be displayed if there are more than 8 characters in a filename. e.g. "TextFile1Mine.txt" will be shown as "TEXTFI~1.TXT"
4. Lower case is not supported and "a"–"z" will be displayed as "A"–"Z" respectively for a filename. e.g. "ABCabc.txt" will be shown as "ABCABC.TXT".

When a file is created, the filename can be input by using the virtual keyboard. Use Navigation Keys to move the cursor, Scan/Select Key to select number(s), Right Soft Key to delete selected number(s). And then press Left Soft Key to complete.

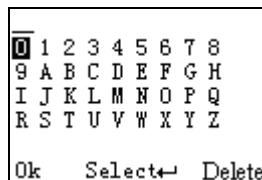

List Files

This menu can be selected to list all files in the root directory. The file selected to be the target file is labeled ✓. The operations described below are imposed to the cursor-on file, which is not necessary to be the target file.

Example:

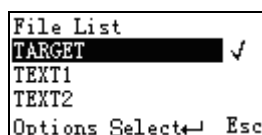

Options Menu

Note: Press Left Soft Key to popup this menu.



Caution:

Empty and Delete operations are not undoable. It is strongly recommended to back up the data before empty or delete operation.

Empty/Delete Files

If the U-disk is almost full, occupied room can be released by emptying/deleting some files. A target file is protected by system and prevented from being deleting. In this case, the file that is wanted to be deleted should be deselected and then deleted.

Format a U Disk

Note 1: The format function is a quick way to empty a whole U Disk.

Note 2: Please format the U Disk once before the first time of use.



Caution:

1. Format operation will erase all data on the disk.
 2. Format operation is not undoable. It is strongly recommended to back up the data before format operation.
-

Data batch

The scanner starts storing barcode data in Date Batch mode. The collected barcode data can then be sent to a host via Bluetooth/USB. Three options are listed below.

Send batch data- Data transmission is triggered by this menu command. Before undertaking this operation, make sure a communication link (Bluetooth network or USB cable) is working.

Interfaces- There are three types of communication interfaces Bluetooth, USB HID keyboard and USB virtual COM. A Bluetooth link is needed in the first case (See System Setting→Bluetooth).

Data statistics- User can select to enable/disable the Data Statistics. When it is enabled, the number of a barcode would be added to the end of the barcode. The eighth barcode is “123456789” in the example below.

Example:

123456789 , 8

5-3 System Setting - Bluetooth

5-3-1 Bluetooth functionalities

The scanner can be configured to send data to a PC/Notebook/PDA/other instrument which has an integrated Bluetooth module or is connected with an external Bluetooth USB adapter. A diagram of Bluetooth functionalities and a table of various Bluetooth profiles are shown below, respectively:



Figure 5-1. Diagram of Bluetooth functionalities

Table 5-1. Various Bluetooth profiles

HID Keyboard	The scanner connects to the PC/host via Bluetooth and behaves like a keyboard. The scanner accepts incoming connection requested from a remote device and is the slave.
SPP slave	The scanner connects to the PC/host via Bluetooth and behaves like there is a serial connection. The scanner accepts incoming connection requested from a remote device and is the Slave.
SPP master	The scanner connects to the PC/host via Bluetooth and behaves like there is a serial connection. The scanner initiates the connection to the remote device and is the Master.

A master SPP mainly differs from a slave one in the process of connection and they are identical in the process of use in terms of function.

Bluetooth-enabled smart phones and PDAs can host the scanner in general. However, ordinary mobile phones with Bluetooth function can not be a host of the scanner because in most cases neither HID nor SPP profile is supported by them.

5-3-2 Configure Bluetooth HID keyboard profile communication

Note: Make sure the Bluetooth module of the scanner is powered on (blue LED is on) and the selected profile is System Setting→Bluetooth→BT HID Keyboard.

Step1. Plug a Bluetooth USB adapter into the USB port of the computer.

Step2. Double-click the Bluetooth icon at the right bottom corner on Windows OS ().

Alternatively, you may go to Control Panel->Bluetooth Device.

Step3. Click to search devices nearby.

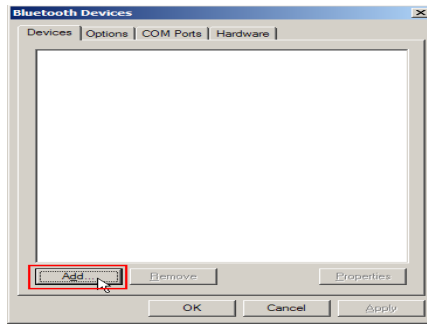

Step4. Click to select “My device is set up and ready to be found” and click **Next**.

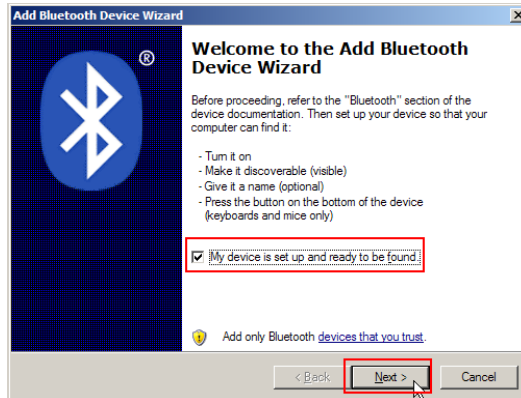

Step5. It takes a few seconds for the Wizard to search devices.

The scanner will appear with its serial number as the device name. If the target scanner is seen on the list, click and select the target scanner. Click **Next**. If the target scanner does not appear on the list, click [Search Again] to refresh the list.

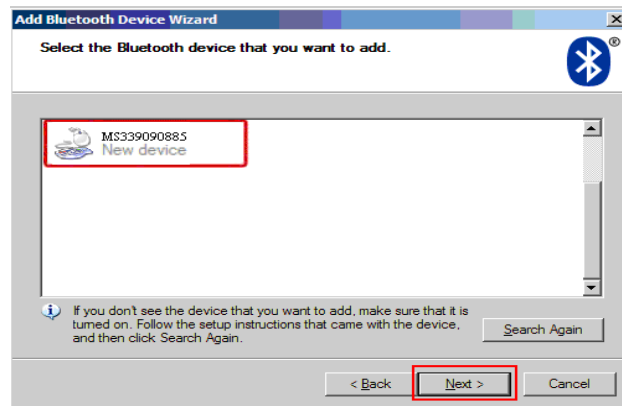

Step6. Click and select “Let me choose my own passkey”. Enter a passkey for authentication and click **Next**.

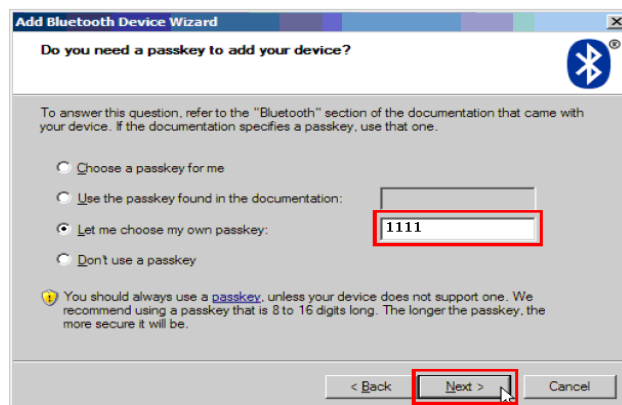

Step7. The scanner promotes the user to accept the connection request. Press Left Soft Key to accept.

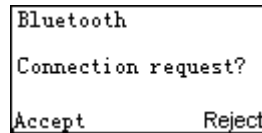

Step8. Enter a passkey which is exactly the same as that entered from the PC. Use Navigation Key to move the cursor, Scan/Select Key to select number(s), Right Software Key to delete selected number. Finally press Left Software Key to continue.

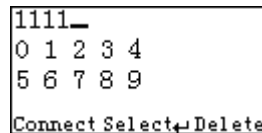

Step9. Wait for a few seconds for Windows to exchange passkeys.

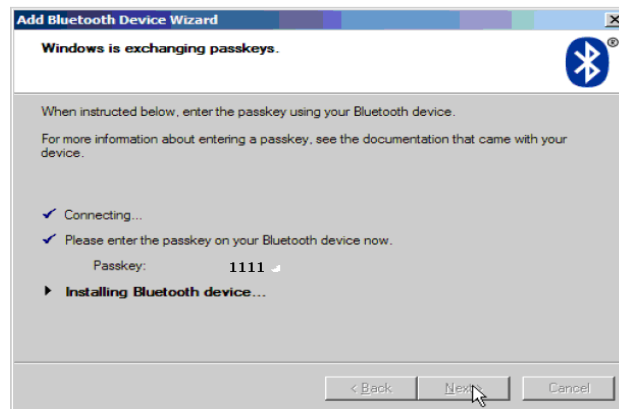

Step10. Click **Finish**



Step11. Now the target scanner will be listed as shown below.

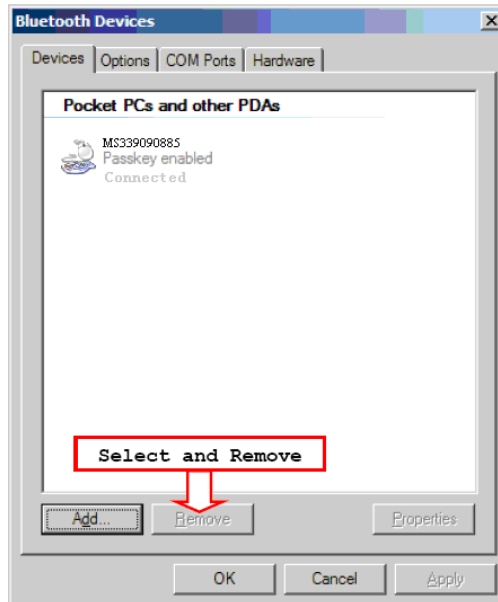

Step12. Run the desired application, such as a Notepad and scan barcodes to check data transmission.

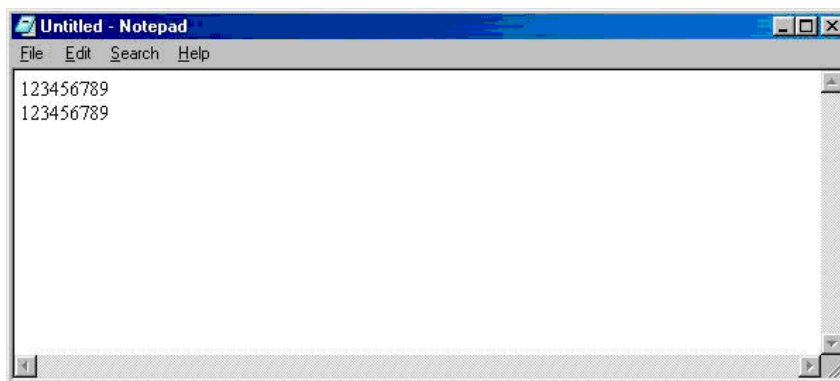

5-3-3 Configure Bluetooth SPP slave profile communication

Note: Make sure the Bluetooth module of the scanner is powered on (blue LED is on) and the selected profile is System Setting→Bluetooth→BT SPP Slave.

Step1-9: The same as Configure Bluetooth HID keyboard step 1~9.

Step10. Click [Finish]

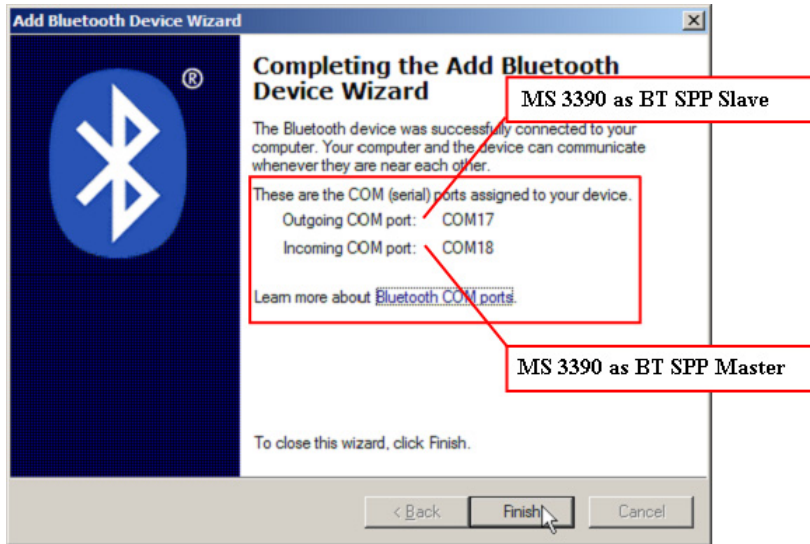

Step11. Now the target scanner will be listed as shown below.

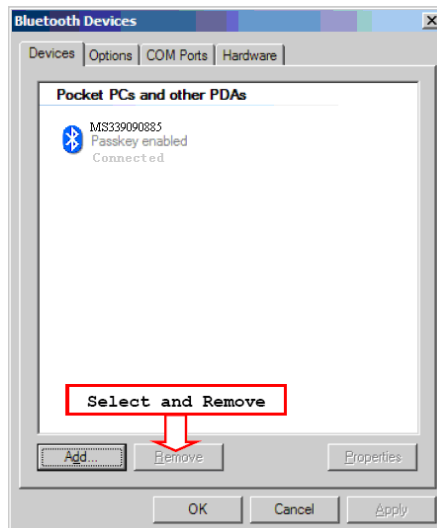

Step12. Run a Serial Port Tool, e.g. HyperTerminal on your computer. This step guarantees the scanner to complete establishing Bluetooth communication. And then scan a barcode to confirm the success of data transmission.

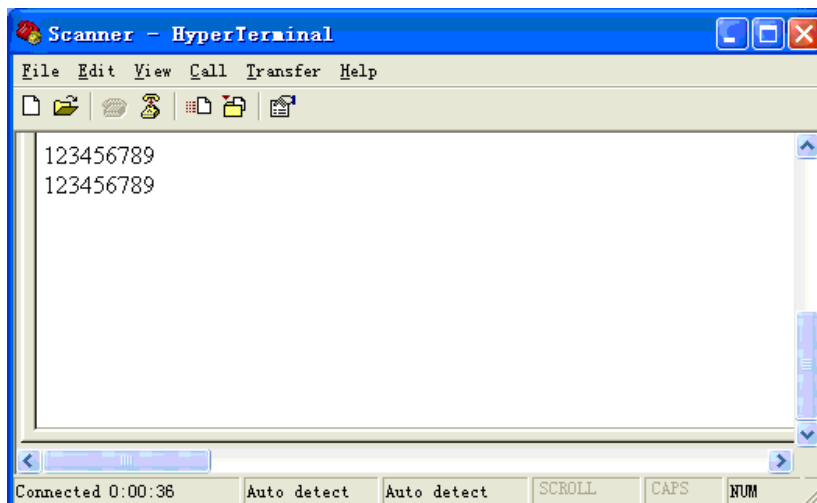

5-3-4 Configure Bluetooth SPP master profile communication

Note: Make sure the Bluetooth module of the scanner is powered on (blue LED is on) and the selected profile is System Setting→Bluetooth→BT SPP Master.

Step1. Press Left Soft Key to the window below. If the scanner has no connection record, it will show the indication” There is no connection record.”

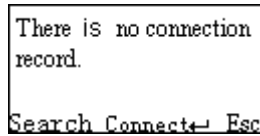

Step2. Press Left Soft Key to the window below for searching.

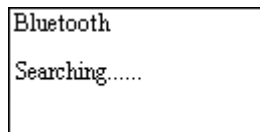

Step3. Wait for about 20 seconds and then the devices list will be shown.



Step4. Use Navigation Key to move the cursor and press Scan/Select Key to connect to the Bluetooth USB adapter.

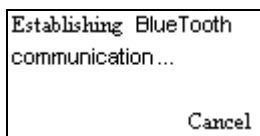

Step5. The remote device will promote user to accept the connection request, and then user enters the passkey. The default passkey of the Bluetooth module of the scanner is “0000”. So enter “0000”, and click .

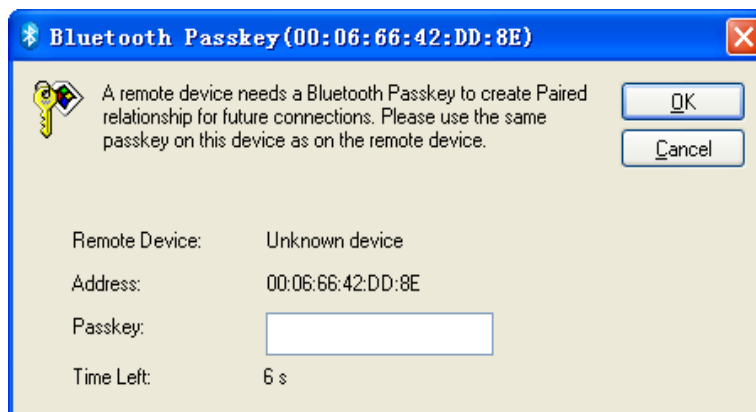

Step6. The Bluetooth device connected to the scanner is labeled √.

Step7. If you want to disconnect the Bluetooth device connected successfully before, you can press Scan/Select Key to disconnect it.

5-3-5 Configure Bluetooth USB adapter BA2110

Notes:

1. BA2110 is provided by the manufacturer to support reliable wireless data transmission and is advised in applications whereas unacknowledged communication is unacceptable.
2. Make sure the Bluetooth module of the scanner is powered on (blue LED is on)
3. By default, the profile of the BA2110 is "USB HID keyboard". An alternative option is "USB virtual COM".

There are two methods to setup the Bluetooth communication.

Method I: scanning special barcode.

There is a barcode on the back of BA2110 as shown below. Scan the barcode. The scanner will beep twice to indicate a successful scan. Please plug the BA2110 into PC within **BA2110 Connect Time**, and then wait for about 5 seconds. The scanner will give 2 long beeps upon a successful connection, or 3 short beeps upon a failed connection.



An example of barcode to indicate a BA2110

Note: For more information of the **BA2110 Connect Time**, please refer to **5-2 Data transfer-Bluetooth-BA2110 Connect Time**.

Method II: operating the scanner on the LCD screen.

Step1. Press Left Soft Key towards the window below. If the scanner has no connection record, it will show the indication of "There is no connection record."

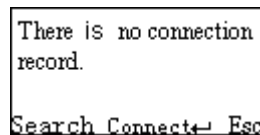

Step2. Press Left Soft Key to the window below for searching.

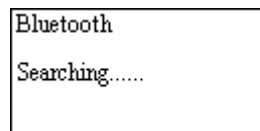

Step3. Wait for about 20 seconds and then BA2110 list will be shown.

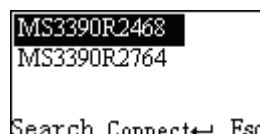

Step4. Use Navigation Key to move the cursor and press Scan/Select Key to connect with BA2110.

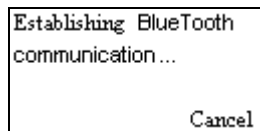

Step5. Wait for about 3 seconds, the scanner will respond with 2 long beeps upon successful connection.

Step6. The BA2110 connected to the scanner is labeled ✓.

Step7. If you want to disconnect the BA2110 connected successfully before, you can press Scan/Select Key to disconnect it.

5-3-6 Configure the profile of BA2110

Note: Before the configuration, make sure the scanner is wireless-connected with the BA2110 successfully.

Step1. Press Left Soft Key to the window below.



Step2. Use Navigation Key to move the cursor and press Scan/Select Key to select items.

USB HID Keyboard

Keyboard layout: The BA2110 supports different national keyboard layouts.

Comm. port speed: By selecting, the user can change the output speed of the BA2110 to match the speed of the host USB communication port. Generally, the default setting is high communication speed mode. If some output characters of barcode have been missed, the user may need to set slow or middle mode to slow the data transmission speed of the scanner.

Numeric key:

Alphabetic key- the scanner will output code result as alphabetic key.

Numeric key- the scanner will output code result as pressing numeric keypad ('0', '1', '2', '3', '4', '5', '6', '7', '8', '9', '.', '+', '-', '/', '*' only).

Alt+ keypad- the scanner will output code result as pressing Alt+ numeric key (on keypad). Note that the Num Lock control key must be ON. This setting can be specially adapted for use with different national keyboard layout.

5-4 System Setting - General

Language

This option is used to select a language for menu display.

Beeper volume

1. Volume

This option is used to control the beeper volume.

2. Keystone

This option is used to turn on/off the Keystone

Vibrator

This option is used to turn on/off the vibrator indicator of a good read.

Backlight timeout

The scanner will switch off the backlight if time of no operation exceeds **Backlight timeout**.

Sleeping timeout

The scanner will enter sleep mode if time of no operation exceeds **Sleeping timeout**. User can set the scanner to sleep mode by press Power/Sleep key (see **Enter/exit sleep mode** and **power on/off Bluetooth**).

Default setting

Default setting includes the scanner and the BA2110.

1. All parameters of the scanner return to default setting.

Table 1 General system setting

Items	Option
Language	English* Chinese
Beeper volume	Low Middle High* Off
Vibrator	Disable Enable*
Backlight timeout	10s 30s*

	60s Off
Sleeping timeout	1min 5min* 10min Off

1. All parameters of the BA2110 return to default setting.

The profile of BA2110 is USB HID Keyboard, Keyboard layout is USA keyboard layout, Comm. port speed mode is high speed mode, and Numeric key type is Alphabetic key.

Notice : To set all parameters of the BA2110 to default setting, please make sure the BA2110 and the scanner are connected properly.

System password

Application of system password relates to user application (for more detail please refers to 6 user customized software development). When this option is enabled, system password is required when switching from user application state back to system state.

If the user download the user customized application software, and enable the boot settings, the system is run directly to the user's application when switched on. When user keep pressing the right soft key during system booting stage, the system password is required before entering the system state. Entering the system state is only allowed after the correct password is provided. Pressing the return key could lead to the user customized application software state.

Notice: The default system password of the scanner is "1234".

Steps for setting the system password:

Step1. Enter the old (previous set) password for verification. Proceed to create new password stage if correct password is provided, otherwise starts over.

Step2. Enter new password.

Step3. Re-enter the new password for verification.

Step4. If the newly entered passwords are identical then creation of new password is successful.

5-5 System Information

View Memory

User can view the used and remain memory capacity in Batch Mode.

```
Total: 8388608 bytes
Used: 0 bytes
Free: 8388608 bytes
Erase Esc
```

Note: User can press Left Soft Key to erase data to release used memory.



Caution:

1. Erasing operation will delete all data in the memory.
2. Erasing operation is not undoable.

Bluetooth Module

User can view the name and address of the Bluetooth module.

Example:

```
Bluetooth
Name: MS339072578
Address:00066842DDB6
Esc
```

Firmware Version

User can view the firmware version of the scanner, scan engine, and Bluetooth module.

6 User customized application software for MS3390

With the support of MS3 SDK, The scanner supports user customized application software development. User customized application software is developed with the support of the scanner system API. For more detail about user customized application software development please refer to the MS3 SDK help files.

User customized application menu in the scanner show as below:

Auto Run

When this option is enabled the scanner would automatically runs the user customized application software after boots. When user keep pressing the right soft key during system booting stage, the system password is required before entering the system state. Entering the system state is only allowed after the correct password is provided. Pressing the return key could lead to the user customized application software state. For more information on system password settings please refer to 5-4 system setting->system password chapter.

Note: It only works after successfully downloaded the user customized application software.

Execute

User could execute the user customized application software by entering the “Execute” menu. Please be sure the user customized application software is properly downloaded to the scanner before execution.

Delete

User could delete the user customized application software by selecting the “Execute” menu and pressing the left soft key-”Delete”.

Download

Enter into this menu to download application by MS3 SDK;

Step1. Power on the scanner, enter into the menu: Application->Download;

Step2. Make sure of connecting the PC and MS3390 well with USB cable;

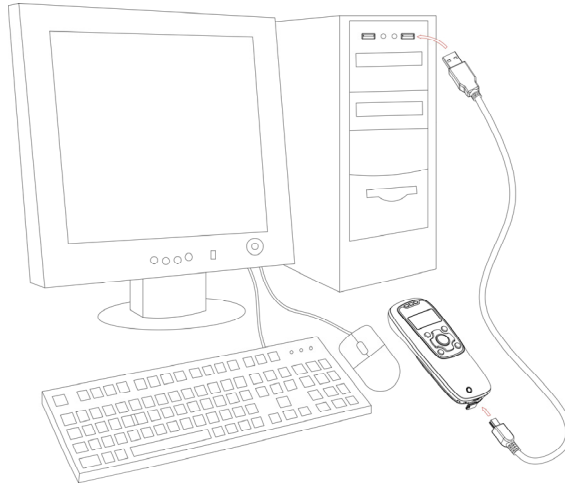

Step3. Clicking on the button  in the toolbar of MS3 SDK to perform download BIN file or ENP file to the scanner;

Step4. After downloaded successfully, the scanner will respond with 2 short beeps.

Installation key for deciphering encrypted file

The scanner provides setting of user customized application software installation key, which use to decipher a secret BIN file(ENP file).Enter into this menu to download Installation key by MS3 SDK (Click Download-> Download Installation Key).

Notice: Please be sure the installation key is properly downloaded to the scanner before you start to download encrypted file (ENP file) to the scanner.

Verification code for user customized application software

The scanner provides setting of user customized application software verification code, which are to be verified with user application by invoking the user application verification API. Examples of user application verification are provided in the mobile scanner software development kit user manual.

Enter into this menu to download Installation key by MS3 SDK.

7 Barcode programming instructions

Programming instruction

Refer to the next page, the steps of programming are:

1. Scan the **SETUP** bar code on the parameter setting part.
2. Enter the option mode by scanning the **Option bar code**.
3. To the right of the option barcode, the necessary alphanumeric inputs are listed. Scan these alphanumeric entries.
4. Scan the **END** bar code, listed on the lower right hand corner of each parameter setting part.
5. **Notes that only one parameter can be setup at each time.**
6. During the process of programming, LED is lighting to indicate the programming correctness. LED will go off if any incorrect programming operation performed.
7. After each successful programming, LED will go off and the scanner will beep twice.
8. Throughout the programming bar code menus, **the factory default settings are indicated with asterisks (*)**.

Example: to set **Flow control** to be XON/XOFF.

Steps: Scan the following barcodes in order.

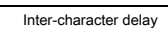
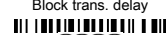
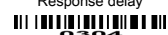

SETUP bar code

Option bar code	Option	Alpha. entry
 0301	None RTS/CTS (Host: Low RTS) RTS/CTS (Host: High RTS) XON/XOFF ACK/NAK	00* 01 02 03 04
 0302	00-99 (ms)	00-99 00*
 0303	00-99 (10 ms)	00-99 00*
 0304	00-99 (100 ms)	00-99 00*

Option bar code

END bar code

Alpha. entries

UPC-A

Read: Format

Leading zero	Data digits (11 digits)	Check digit
--------------	-------------------------	-------------

Check digit verification: The check digit is optional.

Check digit trans.: By setting Enable, check digit will be transmitted.

Code ID setting: Code ID is a one-or-two-character string used to represent the symbol upon a succeeding reading. If you want application to transmit Code ID, you must set **Code ID transmission** to be enabled. Refer to the chapter of String transmission.

Insertion group selection: Refer to **Global insertion group selection** of the chapter of Hand-held scan & some global settings.

Supplement digits: The Supplement digits barcode is the supplemental 2 or 5 characters.

Format

Leading zero	Data digits (11 digits)	Check digit	Supplement digits 2 or 5
--------------	-------------------------	-------------	--------------------------

Truncation/Expansion:

Truncate leading zeros- The leading “0” digits of UPC-A data characters can be truncated when the feature is enabled.

Expand to EAN-13- It extends to 13-digits with a “0” leading digit when the feature is enabled.



Option bar code	Option	Alpha. entry
Read 1101	Disable Enable	00 01*
Check digit verification 1102	Disable Enable	00 01*
Check digit trans. 1103	Disable Enable	00 01*
Code ID setting 1104	00-FF ₁₆ (ASCII)	00-FF ₁₆ <A>*
Insert group selection 1105	00-66	00-66 00*
Supplement digits 1106	None 2 digits 5 digits 2 or 5 digits	00* 01 02 03
Truncation/Expansion 1107	None Truncate leading zeros Expand to EAN-13	00* 01 02
Reserved 1108		



UPC-E

Read: Format

Leading zero	Data digits (6 digits)	Check digits
--------------	------------------------	--------------

Check digit verification: The check digit is optional and made as the sum of the numerical value of the data digits.

Check digit trans.: By setting Enable, check digit will be transmitted.

Code ID setting: Refer to Code ID setting of UPC-A.

Insertion group selection: Refer to Insertion group selection of UPC-A.

Supplement digits:

Format

Leading zero	Data digits (6 digits)	Check digit	Supplement digits 2 or 5
--------------	------------------------	-------------	--------------------------

Truncation/Expansion:

Truncate leading zeros- Refer to Truncation/Expansion of UPC-A.

Expand to EAN-13- It extends to 13-digits with "0" digits when the feature is set to be enabled.

Example: Barcode "0123654",

Output: "0012360000057".

Expand to UPC-A- It extends to 12-digits when the feature is set to be enabled.



Option bar code	Option	Alpha. entry
Read 1201	Disable Enable	00 01*
Check digit verification 1202	Disable Enable	00 01*
Check digit trans. 1203	Disable Enable	00 01*
Code ID setting 1204	00-FF ₁₆ (ASCII)	00-FF ₁₆ <D>*
Insert group selection 1205	00-66	00-66 00*
Supplement digits 1206	None 2 digits 5 digits 2 or 5 digits	00* 01 02 03
Truncation/Expansion 1207	None Truncate leading zeros Expand to EAN-13 Expand to UPC-A	00* 01 02 03
Reserved 1208		



EAN-13

Read:

Format

Data digits (12 digits)	Check digit
-------------------------	-------------

Check digit verification: The check digit is optional and made as the sum of the numerical value of the data digits.

Check digit transmission: By setting Enable, check digit will be transmitted.

Code ID setting: Refer to Code ID setting of UPC-A.

Insertion group selection: Refer to Insertion group selection of UPC-A.

Supplement digits:

Format

Data digits (12 digits)	Check digit	Supplement digits 2 or 5
-------------------------	-------------	--------------------------

ISBN/ISSN: The ISBN (International Standard Book Number) and ISSN (International Standard Serial Number) are two kinds of barcode for books and magazines. The ISBN is 10 digits with leading “978” and the ISSN is 8 digits with leading “977” of the EAN-13 symbology.

Example:

Barcode “9780194315104”, Output: “019431510X”.

Barcode “9771005180004”, Output: “10051805”.



Option bar code	Option	Alpha. entry
Read 1301	Disable Enable	00 01*
Check digit verification 1302	Disable Enable	00 01*
Check digit transmission 1303	Disable Enable	00 01*
Code ID setting 1304	00-FF ₁₆ (ASCII)	00-FF ₁₆ <A>*
Insert group selection 1305	00-66	00-66 00*
Supplement digits 1306	None 2 digits 5 digits 2 or 5 digits	00* 01 02 03
ISBN/ISSN conversion 1307	Disable Enable	00* 01
Reserved 1308		



EAN-8

Read:

Format

Data digits (7 digits)	Check digit
------------------------	-------------

Check digit verification: The check digit is optional and made as the sum of the numerical value of the data digits.

Check digit trans.: By setting Enable, check digit will be transmitted.

Code ID setting: Refer to

Code ID setting

 of UPC-A.

Insertion group selection: Refer to

Insertion group selection

 of UPC-A.

Supplement digits:

Format









Data digits (7 digits)	Check digit	Supplement Digits 2 or 5
------------------------	-------------	--------------------------

Truncation/Expansion: Refer to

Truncation/Expansion

 of UPC-A.

 %SETUP SETUP

Option bar code	Option	Alpha. entry
Read  1401	Disable Enable	00 01*
Check digit verification  1402	Disable Enable	00 01*
Check digit trans.  1403	Disable Enable	00 01*
Code ID setting  1404	00-FF ₁₆ (ASCII)	00-FF ₁₆ <A>*
Insert group selection  1405	00-66	00-66 00*
Supplement digits  1406	None 2 digits 5 digits 2 or 5 digits	00* 01 02 03
Truncation/Expansion  1407	None Truncate leading zero Expand to EAN-13	00* 01 02
Reserved  1408		

 %%%END END

Code 39

Read:

Format

★	Data digits (variable)	Check digit (optional)	★
---	------------------------	------------------------	---

Check digit verification: The check digit is optional and made as the sum module 43 of the numerical value of the data digits.

Check digit transmission: By setting Enable, check digit will be transmitted.

Max./Min. code length: Each symbology has own max./min. code length. If both setting of max./min. code length are "00"s, the setting of global max./min. code length is effective. The length is defined as to the actual barcode data length to be sent. Label with length exceeds these limits will be rejected. Make sure that the minimum length setting is no greater than the maximum length setting, or otherwise all the labels of the symbology will not be readable. In particular, you can see the same value for both minimum and maximum reading length to force the fixed length barcode decoded.

Code ID setting: Refer to

Code ID setting

 of UPC-A.

Insertion group selection: Refer to

Insertion group selection

 of UPC-A.

Start/End transmission: The start and end characters of Code 39 are "★"s. You can transmit all data digits including two "★"s.

★ as data character: By setting Enable, "★" can be recognized as data character.

Convert Code 39 to Code 32: Code 32 is a variant of Code 39 used by the Italian pharmaceutical industry. Note that Code 39 must be enabled in order for this parameter to function.

Format of Code 32

"A" (optional)	Data digits (8 digits)	Check digit
----------------	------------------------	-------------











Code 32 Prefix "A" transmission: By setting Enable, the prefix character "A" can be added to all Code 32 barcodes.

Trioptic Code 39 read: Trioptic Code 39 is a variant of Code 39 used in the marking of magnetic tapes and computer cartridges. Trioptic Code 39 symbols always contain six characters.

Format

\$	Data digits (6 digits)	\$
----	------------------------	----

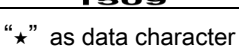
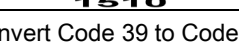
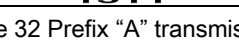
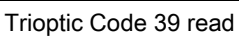
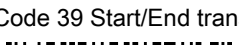
Trioptic Code 39 Start/End transmission: The start and end characters of Trioptic Code 39 are "\$"s. You can transmit all data digits including two "\$"s.

Option bar code	Option	Alpha. entry
Read  1501	Disable Enable	00 01*
Check digit verification  1502	Disable Enable	00* 01
Check digit transmission  1503	Disable Enable	00* 01
Max. code length  1504	00-99	00-99 00*
Min. code length  1505	00-99	00-99 01*
Code ID setting  1506	00-FF ₁₆ (ASCII)	00-FF ₁₆ <M>*
Insert group selection  1507	00-66	00-66 00*
Format  1508	Standard Full ASCII	00* 01
Start/End transmission  1509	Disable Enable	00* 01
“*” as data character  1510	Disable Enable	00* 01
Convert Code 39 to Code 32  1511	Disable Enable	00* 01
Code 32 Prefix “A” transmission  1512	Disable Enable	00* 01
Trioptic Code 39 read  1513	Disable Enable	00* 01
Trioptic Code 39 Start/End transmission  1514	Disable Enable	00* 01

Interleaved 2 of 5

Read:

Format

Data digits (Variable)	Check digit (optional)
------------------------	------------------------

Check digit verification: The check digit is made as the sum module 10 of the numerical values of all data digits. There are two optional check digit algorithms: the specified Uniform Symbology Specification (USS) and the Optical Product Code Council (OPCC).







Check digit transmission: By setting Enable, check digit will be transmitted.

Max./Min. code length: Refer to Max./Min. code length of Code 39.

Code ID setting: Refer to Code ID setting of UPC-A.

Insertion group selection: Refer to Insertion group selection of UPC-A.

 %SETUP SETUP

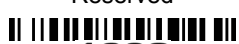
Option bar code	Option	Alpha. entry
Read  1601	Disable Enable	00 01*
Check digit verification  1602	Disable USS OPCC	00* 01 02
Check digit transmission  1603	Disable Enable	00* 01
Max. code length  1604	00-99	00-99 00*
Min. code length  1605	00-99	00-99 06*
Code ID setting  1606	00-FF ₁₆ (ASCII)	00-FF ₁₆ <I>*
Insert group selection  1607	00-66	00-66 00*
Reserved  1608		

 %%%END END

Industrial 2 of 5

Read:

Format







Data digits (variable)

Max./Min. code length: Refer to Max./Min. code length of Code 39.

Code ID setting: Refer to Code ID setting of UPC-A.

Insertion group selection: Refer to Insertion group selection of UPC-A.

 %SETUP SETUP

Option bar code	Option	Alpha. entry
Read  1701	Disable Enable	00* 01
Max. code length  1702	00-99	00-99 00*
Min. code length  1703	00-99	00-99 00*
Code ID setting  1704	00-FF ₁₆ (ASCII)	00-FF ₁₆ <H>*
Insert group selection  1705	00-66	00-66 00*
Reserved  1706		

 %%%END END

Matrix 2 of 5

Read:

Format

Data digits (variable)	Check digit (optional)
------------------------	------------------------

Check digit verification: The check digit is made as the sum module 10 of the numerical values of all data digits.









Check digit transmission: By setting Enable, check digit will be transmitted.

Max./Min. code length: Refer to Max./Min. code length of Code 39.

Code ID setting: Refer to Code ID setting of UPC-A.

Insertion group selection: Refer to Insertion group selection of UPC-A.

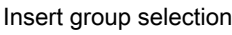
 %SETUP SETUP

Option bar code	Option	Alpha. entry
Read  1801	Disable Enable	00 01*
Check digit verification  1802	Disable Enable	00* 01
Check digit transmission  1803	Disable Enable	00* 01
Max. code length  1804	00-99	00-99 00*
Min. code length  1805	00-99	00-99 06*
Code ID setting  1806	00-FF ₁₆ (ASCII)	00-FF ₁₆ <X>*
Insert group selection  1807	00-44	00-44 00*
Reserved  1808		

 %%%END END

Codabar

Read:

Format

Start	Data digits (variable)	Check digit (optional)	End
-------	------------------------	------------------------	-----

Check digit verification: The check digit is made as the sum module 16 of the numerical values of all data digits.

Check digit transmission: By setting Enable, check digit will be transmitted.

Max./Min. code length: Refer to **Max./Min. code length** of Code 39.

Code ID setting: Refer to **Code ID setting** of UPC-A.



Insertion group selection: Refer to **Insertion group selection** of UPC-A.

Start/End type: Codabar has four pairs of Start/End pattern; you may select one pair to match your application.

Start/End transmission: Refer to **Start/End transmission** of Code 39.

Start/End character equality: By setting Enable, the start and end character of a Codabar barcode must be the same.

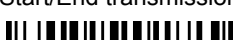

Option bar code	Option	Alpha. entry
Read  1901	Disable Enable	00 01*
Check digit verification  1902	Disable Enable	00* 01
Check digit transmission  1903	Disable Enable	00* 01
Max. code length  1904	00-99	00-99 00*
Min. code length  1905	00-99	00-99 00*
Code ID setting  1906	00-FF ₁₆ (ASCII)	00-FF ₁₆ <N>*
Insert group selection  1907	00-66	00-66 00*
Start/End type  1908	ABCD/ABCD abcd/abcd ABCD/TN*E abcd/tn*e	00* 01 02 03
Start/End transmission  1909	Disable Enable	00* 01
Start/End character equality  1910	Disable Enable	00* 01



Code 128

Read:

Format

Data digits (variable)	Check digit (optional)
------------------------	------------------------

Check digit verification: The check digit is made as the sum module 103 of all data digits.

Check digit transmission: By setting Enable, check digit will be transmitted.

Max./Min. code length: Refer to **Max./Min. code length** of Code 39.

Code ID setting: Refer to **Code ID setting** of UPC-A.

Insertion group selection: Refer to **Insertion group selection** of UPC-A.

Truncate leading zeros: The leading “0” digits of Code 128 barcode characters can be truncated when the feature is enabled.



Option bar code	Option	Alpha. entry
Read 2001	Disable Enable	00 01*
Check digit verification 2002	Disable Enable	00 01*
Check digit transmission 2003	Disable Reserved	00* 01
Max. code length 2004	00-99	00-99 00*
Min. code length 2005	00-99	00-99 01*
Code ID setting 2006	00-FF ₁₆ (ASCII)	00-FF ₁₆ <K>*
Insert group selection 2007	00-66	00-66 00*
Truncate leading zeros 2008	Disable All leading “0”s Only the first “0”	00* 01 02



Code 93

Read:

Format

Data digits (variable)	2 check digits (optional)
------------------------	---------------------------

Check digit verification: The check digit is made as the sum module 47 of the numerical values of all data digits.

Check digit transmission: By setting Enable, check digit will be transmitted.

Max./Min. code length: Refer to Max./Min. code length of Code 39.

Code ID setting: Refer to Code ID setting of UPC-A.

Insertion group selection: Refer to Insertion group selection of UPC-A.



Option bar code	Option	Alpha. entry
Read 2101	Disable Enable	00 01*
Check digit verification 2102	Disable Enable	00 01*
Check digit transmission 2103	Disable Enable	00* 01
Max. code length 2104	00-99	00-99 00*
Min. code length 2105	00-99	00-99 01*
Code ID setting 2106	00-FF ₁₆ (ASCII)	00-FF ₁₆ <L>*
Insert group selection 2107	00-66	00-66 00*
Reserved 2108		



Code 11

Read:

Format

Data digits (variable)	Check digit 1 (optional)	Check digit 2 (optional)
------------------------	--------------------------	--------------------------

Check digit verification: The check digit is presented as the sum module 11 of all data digits.









Check digit transmission: By setting Enable, check digit 1 and check digit 2 will be transmitted upon your selected check digit verification method.

Max./Min. code length: Refer to Max./Min. code length of Code 39.

Code ID setting: Refer to Code ID setting of UPC-A.

Insertion group selection: Refer to Insertion group selection of UPC-A.

 %SETUP SETUP

Option bar code	Option	Alpha. entry
Read  2201	Disable Enable	00* 01
Check digit verification  2202	Disable One digit Reserved Reserved	00 01* 02 03
Check digit transmission  2203	Disable Enable	00* 01
Max. code length  2204	00-99	00-99 00*
Min. code length  2205	00-99	00-99 00*
Code ID setting  2206	00-FF ₁₆ (ASCII)	00-FF ₁₆ <V>*
Insert group selection  2207	00-66	00-66 00*
Reserved  2208		

 %%%END END

MSI/Plessey

Read:

Format

Data digits (variable)	Check digit 1 (optional)	Check digit 2 (optional)
------------------------	--------------------------	--------------------------

Check digit verification: The MSI/Plessey has one or two optional check digits. There are three methods of verifying check digits, i.e. Mod10, Mod10/10 and Mod 11/10. The check digit 1 and check digit 2 will be calculated as the sum module 10 or 11 of the data digits.









Check digit transmission: By setting Enable, check digit 1 and check digit 2 will be transmitted upon your selected check digit verification method.

Max./Min. code length: Refer to Max./Min. code length of Code 39.

Code ID setting: Refer to Code ID setting of UPC-A.

Insertion group selection: Refer to Insertion group selection of UPC-A.

 %SETUP SETUP

Option bar code	Option	Alpha. entry
Read  2301	Disable Enable	00* 01
Check digit verification  2302	Disable 1 digit (mod 10) Reserved Reserved	00* 01 02 03
Check digit transmission  2303	Disable Enable	00* 01
Max. code length  2304	00-99	00-99 00*
Min. code length  2305	00-99	00-99 00*
Code ID setting  2306	00-FF ₁₆ (ASCII)	00-FF ₁₆ <O>*
Insert group selection  2307	00-66	00-66 00*
Reserved  2308		

 %%%END END

UK/Plessey

Read:

Format

Data digits (variable)	2 check digits (optional)
------------------------	---------------------------

Check digit verification: The UK/Plessey has one or two optional check digits. The check digit 1 and check digit 2 will be calculated as the sum module 10 or 11 of the data digits.







Check digit transmission: By setting Enable, check digit will be transmitted.

Max./Min. code length: Refer to Max./Min. code length of Code 39.

Code ID setting: Refer to Code ID setting of UPC-A.

Insertion group selection: Refer to Insertion group selection of UPC-A.

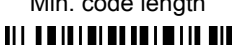
 %SETUP SETUP

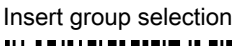
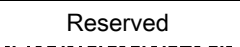
Option bar code	Option	Alpha. entry
Read  2401	Disable Enable	00* 01
Check digit verification  2402	Disable Enable	00 01*
Check digit transmission  2403	Disable Enable	00* 01
Max. code length  2404	00-99	00-99 00*
Min. code length  2405	00-99	00-99 01*
Code ID setting  2406	00-FF ₁₆ (ASCII)	00-FF ₁₆ <U>*
Insert group selection  2407	00-66	00-66 00*
Reserved  2408		

 %%%END END

UCC/EAN 128

Read:

Format

Data digits (variable)	Check digit (optional)
------------------------	------------------------

Check digit verification: The check digit is made as the sum module 103 of all data digits.

Check digit transmission: By setting Enable, check digit will be transmitted.









Max. /Min. code length: Refer to Max./Min. code length of Code 39.

Code ID setting: Refer to Code ID setting of UPC-A.

Insertion group selection: Refer to Insertion group selection of UPC-A.

Truncate leading zeros: Refer to Truncate leading zeros of Code 128.

 %SETUP SETUP

Option bar code	Option	Alpha. entry
Read  2501	Disable Enable	00 01*
Check digit verification  2502	Disable Enable	00 01*
Check digit transmission  2503	Disable Reserved	00* 01
Max. code length  2504	00-99	00-99 00*
Min. code length  2505	00-99	00-99 01*
Code ID setting  2506	00-FF ₁₆ (ASCII)	00-FF ₁₆ <K>*
Insert group selection  2507	00-66	00-66 00*
Truncate leading zeros  2508	Disable All leading "0"s Only the first "0"	00* 01 02

 %%%END END

China Post

Read:

Format





11 Data digits

Max. /Min. code length: Refer to **Max./Min. code length** of Code 39. The code length of China Post is 11.

Code ID setting: Refer to **Code ID setting** of UPC-A.

Insertion group selection: Refer to **Insertion group selection** of UPC-A.

 %SETUP SETUP

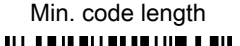
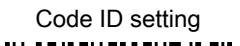
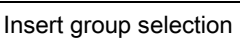
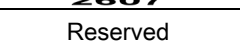
Option bar code	Option	Alpha. entry
Read  2601	Disable Enable	00 01*
Reserved  2602		
Reserved  2603		
Max. code length  2604	00-99	00-99 11*
Min. code length  2605	00-99	00-99 11*
Code ID setting  2606	00-FF ₁₆ (ASCII)	00-FF ₁₆ <T>*
Insert group selection  2607	00-66	00-66 00*
Reserved  2608		

 %%%END END

GS1 DataBar (GS1 DataBar Truncated)

GS1 DataBar Truncated is structured and encoded the same as the standard GS1 DataBar format, except its height is reduced to a 13 modules minimum; while GS1 DataBar should have a height greater than or equal to 33 modules.

Read:

Format

16 Data digits

Code ID setting: Refer to **Code ID setting** of UPC-A.





Insertion group selection: Refer to **Insertion group selection** of UPC-A.

Conversion:

UCC/EAN 128- Refer to **Code ID transmission** of String transmission,]Cm will be identified as AIM ID.

UPC-A or EAN-13- Barcode beginning with a single zero as the first digit has the leading "010" stripped and the barcode reported as EAN-13. Barcode beginning with two or more zeros but not six zeros has the leading "0100" stripped and the barcode reported as UPC-A.

 %SETUP SETUP

Option bar code	Option	Alpha. entry
Read  2701	Disable Enable	00 01*
Code ID setting  2702	00-FF ₁₆ (ASCII)	00-FF ₁₆ <R >*
Insert group selection  2703	00-66	00-66 00*
Conversion  2704	None UCC/EAN 128 UPC-A or EAN-13	00* 01 02
Reserved  2705		

 %%%END END

GS1 DataBar Limited

Read:

Format





16 Data digits

Code ID setting: Refer to Code ID setting of UPC-A.

Insertion group selection: Refer to Insertion group selection of UPC-A.

Conversion: Refer to Conversion of GS1 DataBar (GS1 DataBar Truncated).

 %SETUP SETUP

Option bar code	Option	Alpha. entry
Read  2801	Disable Enable	00 01*
Code ID setting  2802	00-FF ₁₆ (ASCII)	00-FF ₁₆ <R >*
Insert group selection  2803	00-66	00-66 00*
Conversion  2804	None UCC/EAN 128 UPC-A or EAN-13	00* 01 02
Reserved  2805		

 %%%END END

GS1 DataBar Expanded

Read:

Format

Data characters (variable)







Code ID setting: Refer to Code ID setting of UPC-A.

Insertion group selection: Refer to Insertion group selection of UPC-A.

Conversion:

UCC/EAN 128- Refer to Code ID transmission of String transmission,]Cm will be identified as AIM ID.

%SETUP SETUP

Option bar code	Option	Alpha. entry
Read  2901	Disable Enable	00 01*
Max. code length  2902	00-99	00-99 00*
Min. code length  2903	00-99	00-99 01*
Code ID setting  2904	00-FF ₁₆ (ASCII)	00-FF ₁₆ <R >*
Insert group selection  2905	00-66	00-66 00*
Conversion  2906	None UCC/EAN 128	00* 01
Reserved  2907		

%%%END END

PDF417

This decoder is only applied with a specified firmware.

The symbol size in the standard of PDF417 says, number of rows: 3 to 90, and number of columns: 1 to 30. This scanner can only decode PDF417 at rows from 3 to 40 and columns from 1 to 20.

The error correction level for a PDF417 symbol is from 0 to 8. This scanner can only support the levels from 0 to 6.

Read:





Format

Data characters (variable)

Code ID setting: Refer to Code ID setting of UPC-A.

Insertion group selection: Refer to Insertion group selection of UPC-A.

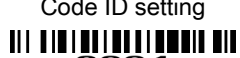
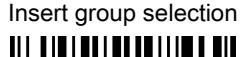
 %SETUP SETUP

Option bar code	Option	Alpha. entry
Read  3001	Disable Enable	00* 01
Max. code length  3002	00-99	00-99 00*
Min. code length  3003	00-99	00-99 01*
Code ID setting  3004	00-FF ₁₆ (ASCII)	00-FF ₁₆ <P>*
Insert group selection  3005	00-66	00-66 00*
Reserved  3006		

 %%%END END

MicroPDF417

This decoder is only applied with a specified firmware.

Read:

Format







Data characters (variable)

Max. /Min. code length: Refer to Max./Min. code length of Code 39.

Code ID setting: Refer to Code ID setting of UPC-A.

Insertion group selection: Refer to Insertion group selection of UPC-A.

%SETUP SETUP

Option bar code	Option	Alpha. entry
Read  3101	Disable Enable	00* 01
Max. code length  3102	00-99	00-99 00*
Min. code length  3103	00-99	00-99 01*
Code ID setting  3104	00-FF ₁₆ (ASCII)	00-FF ₁₆ <P>*
Insert group selection  3105	00-66	00-66 00*
Reserved  3106		
Reserved  3107		

%%%END END

China Finance

Note: This type of barcode is not Omni-directionally decodable. The encodable character set includes numeric 0 to 9. Among the symbol of 0 to 9, 0 and 2, 4 and 9, 5 and 8, 6 and 7, have the symmetrical pattern; the pattern of 1 and 3 is symmetrical.

Read:

Format

10 Data digits

Max./Min. code length: Refer to **Max./Min. code length** of Code 39.







Check digit verification: The check digit is made as the sum module 10 of the numerical values of all data digits.

Leading character 5/6/7/8/9 converted to A/B/C/D/E: By setting, leading character 5/6/7/8/9 can be converted to A/B/C/D/E.

Leading character assignment: By setting, only the barcode with the assigned leading character can be output.

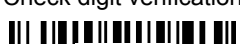
Code ID setting: Refer to **Code ID setting** of UPC-A.

Insertion group selection: Refer to **Insertion group selection** of UPC-A.

Option bar code	Option	Alpha. entry
Read  3201	Disable Enable	00 01*
Max. code length  3202	00-99	00-99 10*
Min. code length  3203	00-99	00-99 10*
Check digit verification  3204	Disable Reserved	00* 01
Leading character 5/6/7/8/9 converted to A/B/C/D/E  3205	Disable Enable Only 5 converted to A Only 6 converted to B Only 7 converted to C Only 8 converted to D Only 9 converted to E	00 01* 02 03 04 05 06
Leading character assignment  3206	Disable Assigned to 0 Assigned to 5(A) Assigned to 6(B) Assigned to 7(C) Assigned to 8(D) Assigned to 9(E) Assigned to 1 Assigned to 2 Assigned to 3 Assigned to 4	00 01* 02 03 04 05 06 07 08 09 10
Code ID setting  3207	00-FF ₁₆ (ASCII)	00-FF ₁₆ <Y>*
Insert group selection  3208	00-66	00-66 00*



Laser Light Direction Setting: By scanning the barcode above, the decoding direction of the scanner's laser light is from left to right. By scanning the up-side-down barcode above, the decoding direction of the scanner's laser light is from right to left.

G1-G6 & FN1 substitution string setting

Format of barcode data transmission

Prefix	Code name	Preamble	Code ID	Code length	Code data	Code ID	Postamble	Suffix
--------	-----------	----------	---------	-------------	-----------	---------	-----------	--------

Suffix string setting: The <enter> key is represented in different ASCII when it is applied by different OS. For a Windows/DOS OS, <enter> is represented as <CR><LF> (0x0D 0x0A); for an APPLE MAC OS, <enter> is represented as <CR> (0x0D); for a Linux/Unix OS, <enter> is represented as <LF> (0x0A).

Prefix/Suffix string setting: & Preamble/Postamble string setting:

They are appended to the data automatically when a barcode is decoded.

Example: Add a symbol of “\$” as a prefix for all symbologies.

Steps:

- 1) Scan **SETUP** and **Prefix string setting** barcode.
- 2) Use the ASCII table to find the value of \$→24.
- 3) Scan **2** and **4** from the barcode on the foldout back page.
- 4) Scan **END** barcode.

Scanning steps: Scan the following barcodes in order.



Insert G1/G2/G3/G4 string setting: The scanner offers 4 positions and 4 character strings to insert among the symbol.

Example: Set G1 string to be “AB”.

Original code data	“1 2 3 4 5 6”
Output code data	“1 2 A B 3 4 5 6”

Steps:

- 1) Scan **SETUP** and **Insert G1 string setting** barcode “8005”.
- 2) Use the ASCII table to find the value of A→41, B→42.
- 3) Scan **4**, **1** and **4**, **2** from the barcode on the foldout back page.
- 4) Scan **END** barcode.
- 5) Refer to the chapter of G1-G4 string position & Code ID position.
- 6) Refer to the chapter of Hand-held scan & some global settings.



Testing barcode:



FN1 substitution string setting: The FN1 character (0x1D) in an UCC/EAN128 barcode, or a Code 128 barcode, or a GS1 DataBar barcode can be substituted with a defined string.

Truncate leading G5 string setting: By setting, a defined leading character or string can be truncated. Also a single character can be un-defined.

Repeat of a G5 character setting: While G5 is set as a single defined/un-defined character, G5 can also be set to be repeated. This setting is ignored when the truncate number is more than the barcode data characters. The option of “FF” for this setting is not active while the option of **Truncate leading G5 string setting** is “00”.

Example: Truncate all leading zeros for all symbologies.

Original code data	“0 0 0 1 2 3 4 5 6”
Output code data	“1 2 3 4 5 6”

Steps: scan the following data in order.

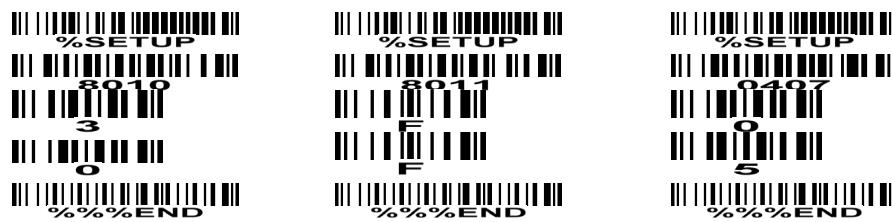

Testing barcode:



Truncate ending G6 string setting: By setting, a defined ending character or string can be truncated. Also a single character can be un-defined.

Repeat of a G6 character setting: While G5 is set as a single defined/un-defined character, G6 can also be set to be repeated. This setting is ignored when the truncate number is more than the barcode data characters. The option of “FF” for this setting is not active while the option of **Truncate ending G6 string setting** is “00”.

Single character C1/C2 replacement: By setting, a defined character in the data string can be replaced by another defined character. The C1 and C2 replacement are applied simultaneously.

Example: Replace all the “A” character in a data string to be “B” character.













Original code data	“1 2 3 A 5 A”
Output code data	“1 2 3 B 5 B”

Steps: scan the following barcodes in order. The ASCII value for “A” is 41, and the ASCII value for “B” is 42.

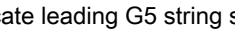
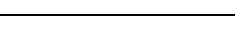

Testing barcode:

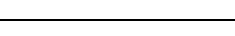

Option bar code	Option	Alpha. entry
Prefix string setting  8001	0-22 characters None	00-FF ₁₆ 00*
Suffix string setting  8002	0-22 characters <ENTER>	00-FF ₁₆ 0D0A*
Preamble string setting  8003	0-22 characters None	00-FF ₁₆ 00*
Postamble string setting  8004	0-22 characters None	00-FF ₁₆ 00*
Insert G1 string setting  8005	0-22 characters None	00-FF ₁₆ 00*
Insert G2 string setting  8006	0-22 characters None	00-FF ₁₆ 00*
Insert G3 string setting  8007	0-22 characters None	00-FF ₁₆ 00*
Insert G4 string setting  8008	0-22 characters None	00-FF ₁₆ 00*
FN1 substitution string setting  8009	0-4 characters <SP>	00-FF ₁₆ 20*
Truncate leading G5 string setting  8010	A un-defined character 1-22 defined characters <0>	00 01-7F ₁₆ 30*
Repeat of a G5 character setting  8011	Once Defined times Un-defined times (All)	01* 01-22 FF
Truncate ending G6 string setting  8012	A un-defined character 1-22 defined characters <0>	00 01-7F ₁₆ 30*
Repeat of a G6 character setting  8013	Once Defined times Un-defined times (All)	01* 01-22 FF
Single character C1 replacement  8014	<0000>	0000* 0000-FFFF ₁₆
Single character C2 replacement  8015	<0000>	0000* 0000-FFFF ₁₆

G1-G4 string position & Code ID position







Format of barcode data transmission

Prefix	Code name	Preamble	Code ID	Code length	Code data	Code ID	Postamble	Suffix
--------	-----------	----------	---------	-------------	-----------	---------	-----------	--------

Insert G1/G2/G3/G4 string position: The scanner offers 4 positions to insert strings among the symbol. In case of the insertion position is greater than the length of the symbol, the insertion of string is not effective.

Code ID position: It is allowed to select different positions of code ID placement.



Option bar code	Option	Alpha. entry
Insert G1 string position  8101	00-99	00-99 00*
Insert G2 string position  8102	00-99	00-99 00*
Insert G3 string position  8103	00-99	00-99 00*
Insert G4 string position  8104	00-99	00-99 00*
Code ID position  8105	Before code data After code data	00* 01
Reserved  8106		
Reserved  8107		



String transmission

Note: The information in this chapter is closely related to the chapter of String setting.

Format of barcode data transmission

Prefix	Code name	Preamble	Code ID	Code length	Code data	Code ID	Postamble	Suffix
--------	-----------	----------	---------	-------------	-----------	---------	-----------	--------

Prefix transmission: By setting Enable, prefix will be appended before the data transmitted.

Suffix transmission: By setting Enable, suffix will be appended after the data is transmitted.

Code name transmission: By setting Enable, code name will be transmitted before code data.

Preamble transmission: By setting Enable, preamble will be appended before the data transmitted.

Postamble transmission: By setting Enable, postamble will be appended after the data is transmitted.

Code ID transmission: Code ID can be transmitted in the format of either Proprietary ID or AIM ID.

Refer to the chapter of Default setting for each barcode.











Code length transmission: The length of code data string can be transmitted before the code data when Enable is selected. The length is represented by a number with two digits.

Case conversion: The characters within code data or the whole output string can be set in either upper case or lower case.

FN1 substitution transmission: The scanner supports a FN1 substitution feature for keyboard wedge, USB and RS-232 interface. The replacement string of FN1 can be chosen by user (see chapter of G1-G6 & FN1 substitution string setting).

All-non-printable-character string transmission with string setting: By setting enable, all string settings, e.g. Preamble transmission or Insert G1 string setting, are active for an all-non-printable-character string. Here a non-printable character means a character with ASCII value between 0x00 to 0x1F.

 %SETUP SETUP

Option bar code	Option	Alpha. entry
Prefix transmission  8201	Disable	00*
	Enable	01
Suffix transmission  8202	Disable	00
	Enable	01*
Code name transmission  8203	Disable	00*
	Enable	01
Preamble transmission  8204	Disable	00*
	Enable	01
Postamble transmission  8205	Disable	00*
	Enable	01
Code ID transmission  8206	Disable	00*
	Proprietary ID	01
	AIM ID	02
Code length transmission  8207	Disable	00*
	Enable	01
Case conversion  8208	Disable	00*
	Upper (data only)	01
	Lower (data only)	02
	Upper (whole string)	03
	Lower (whole string)	04
FN1 substitution transmission  8209	Disable	00*
	Keyboard wedge/USB	01
	RS-232	02
	Keyboard wedge/USB/RS-232	03
All-non-printable-character string transmission with string setting  8210	Disable	00*
	Enable	01

 %%%END END

Test Chart

UPC-A



UPC-E



EAN-8



EAN-13



Code 39



Code 32



Code 128



Interleaved 2 of 5



Industrial 2 of 5

(Default setting: Read disable)



Matrix 2 of 5



Code 93



UCC/EAN 128



Code 11

(Default setting: Read disable)



Test Chart (Continued)

MSI/Plessey

(Default setting: Read disable)



0123456789

UK/Plessey



01ABEF89

ISBN/ISSN



9 780194 315104

China Post



54789632145

GS1 DataBar (GS1 DataBar Truncated)



1234567890123

GS1 DataBar Limited



987654321012

GS1 DataBar Expanded



Ab_09+yZ

PDF417



01Az+ -=

MicroPDF417



23+-mdo

ASCII Table

		for keyboard wedge		for RS-232	
H L	0	1	0	1	
0	Null		NUL	DLE	
1	Up	F1	SOH	DC1	
2	Down	F2	STX	DC2	
3	Left	F3	ETX	DC3	
4	Right	F4	EOT	DC4	
5	PgUp	F5	ENQ	NAK	
6	PgDn	F6	ACK	SYN	
7		F7	BEL	ETB	
8	Bs	F8	BS	CAN	
9	Tab	F9	HT	EM	
A		F10	LF	SUB	
B	Home	Esc	VT	ESC	
C	End	F11	FF	FS	
D	Enter	F12	CR	GS	
E	Insert	Ctrl+	SO	RS	
F	Delete	Alt+	SI	US	

Notes: The 2nd and the 3rd columns above are used for keyboard wedge only.

H L	2	3	4	5	6	7
0	SP	0	@	P	`	p
1	!	1	A	Q	a	q
2	“	2	B	R	b	r
3	#	3	C	S	c	s
4	\$	4	D	T	d	t
5	%	5	E	U	e	u
6	&	6	F	V	f	v
7	‘	7	G	W	g	w
8	(8	H	X	h	x
9)	9	I	Y	i	y
A	*	:	J	Z	j	z
B	+	;	K	[k	{
C	,	<	L	\	l	
D	-	=	M]	m	}
E	.	>	N	^	n	~
F	/	?	O	_	o	DEL

Example: ASCII “A” = “41”.

Barcode representing non-printable character

Notes to make the following barcode:

1. According to different barcode printing software, the method of printing following barcode is different.
2. If using CODESOFT software, firstly read the information through “Help→Index→Code128→Special input syntax”. Also refer to ASCII table. For example, if we wish to make “F1” barcode, select “code128”, then select “CODE A” type, and input “{DOC1}” as data.



Up ↑



Down ↓



Left ←



Right →



Page Up



Page Down



Backspace



Tab



Home



End



Enter



Insert



Delete



F1



F2



F3



F4



F5



F6



F7



F8



F9



F10



Esc



F11



F12

Configuration alphanumeric entry barcode



0



1



2



3



4



5



6



7



8



9



A



B



C



D



E



F